

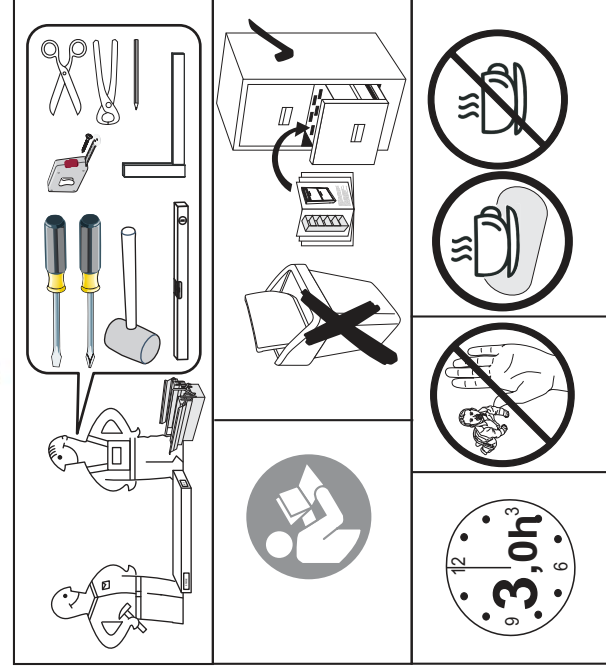

Assembling instruction / Montageanleitung / Notice de montage / Montaje de instrucción / Instrukcja montażu / Сборка инструкция / Montáž instrukce / Montáž inštrukcie / Szerelési utasítás / Сглюбяване инструкция / Kurulum Talimatları / Montagem de instrução / Sestavljanje navodila / Montage instructie / Skлапање инструкция / Asamblarea de instruciuni / Sastavljanje upute / Montering instruktion / Istruzioni di montaggio / Збірка інструкція / Montāžas instrukcija / Montavimo instrukcija / Raigaldusjuhend / Kokoamisohjeisiin

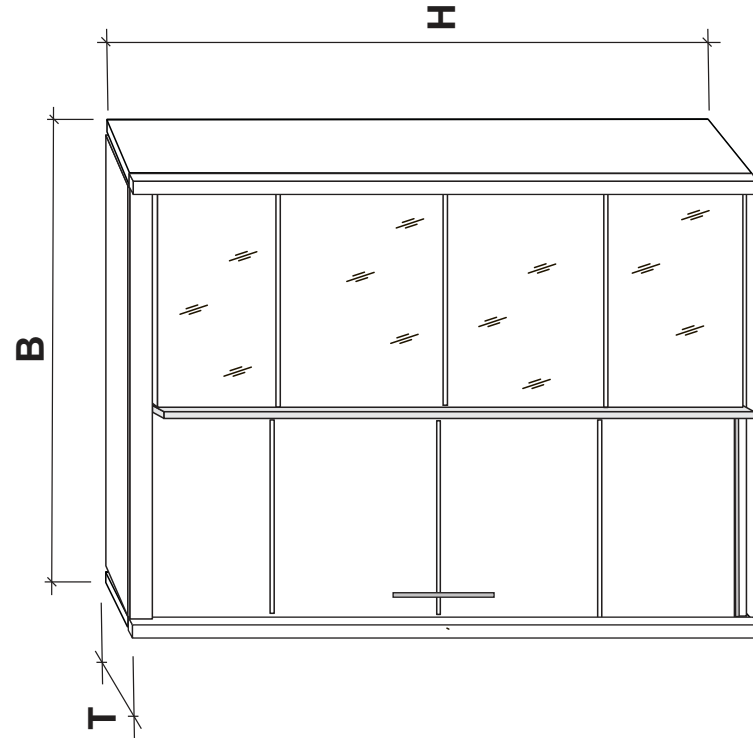

B - 200 cm
H - 216 cm
T - 62 cm
174 KG



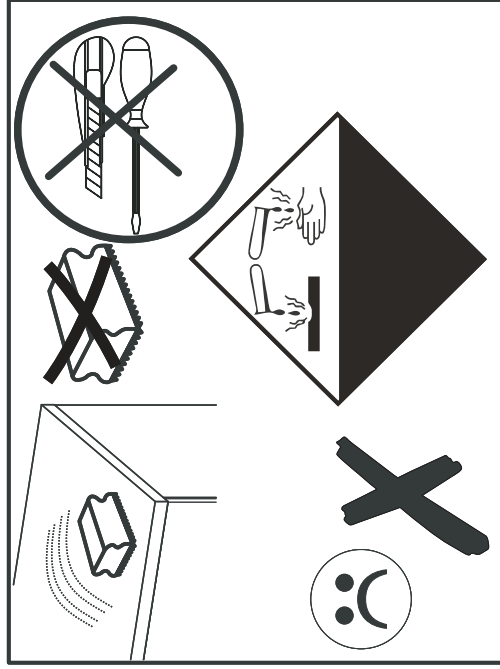
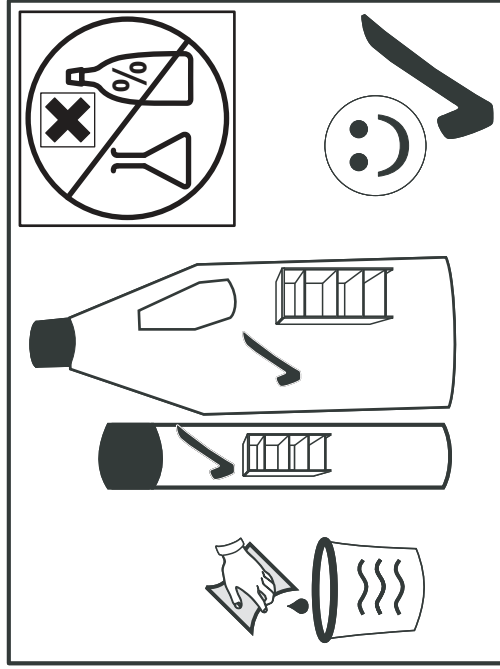
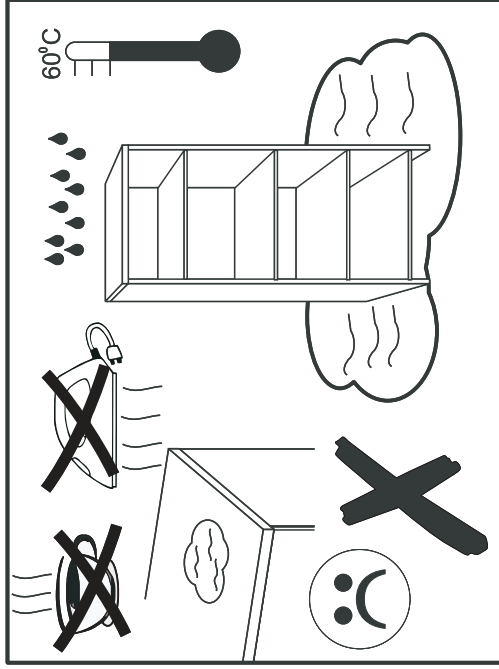
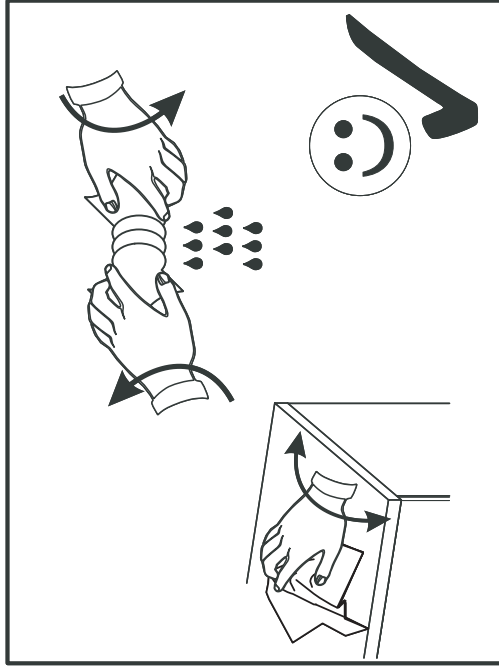
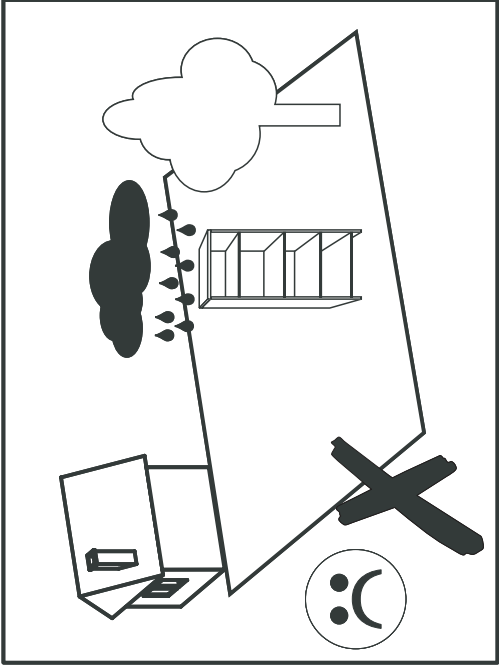
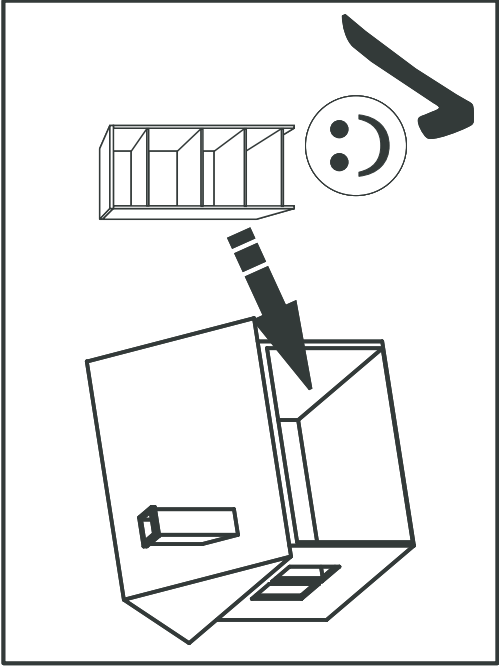
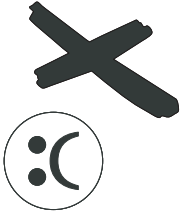
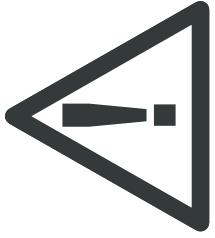

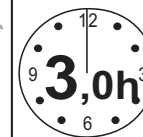
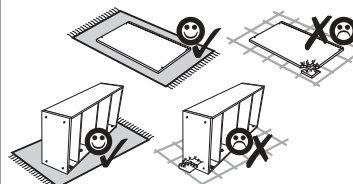
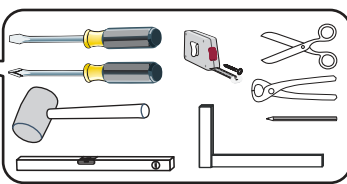
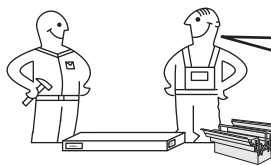
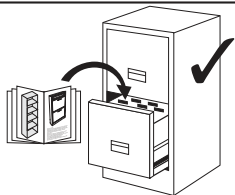
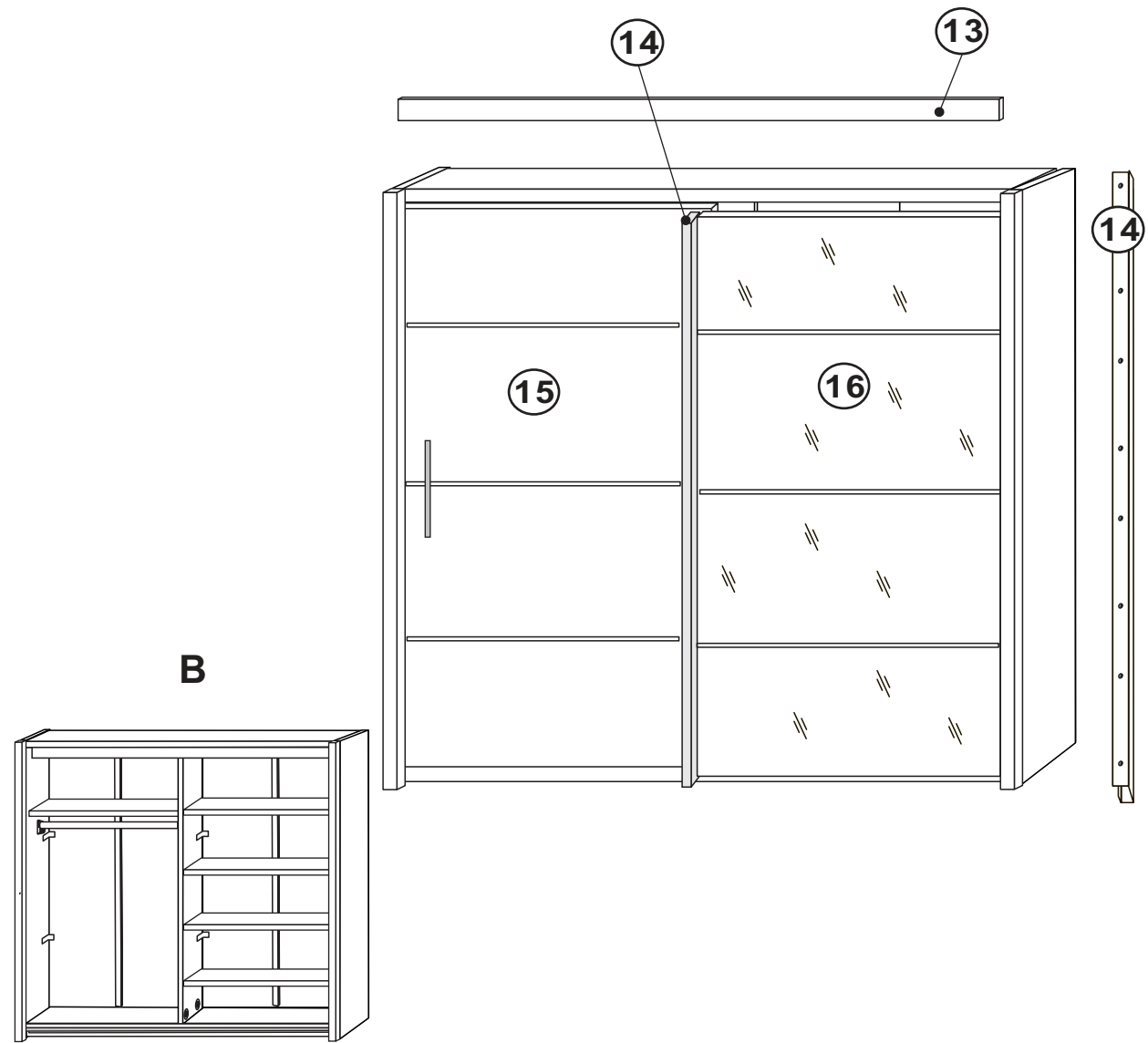
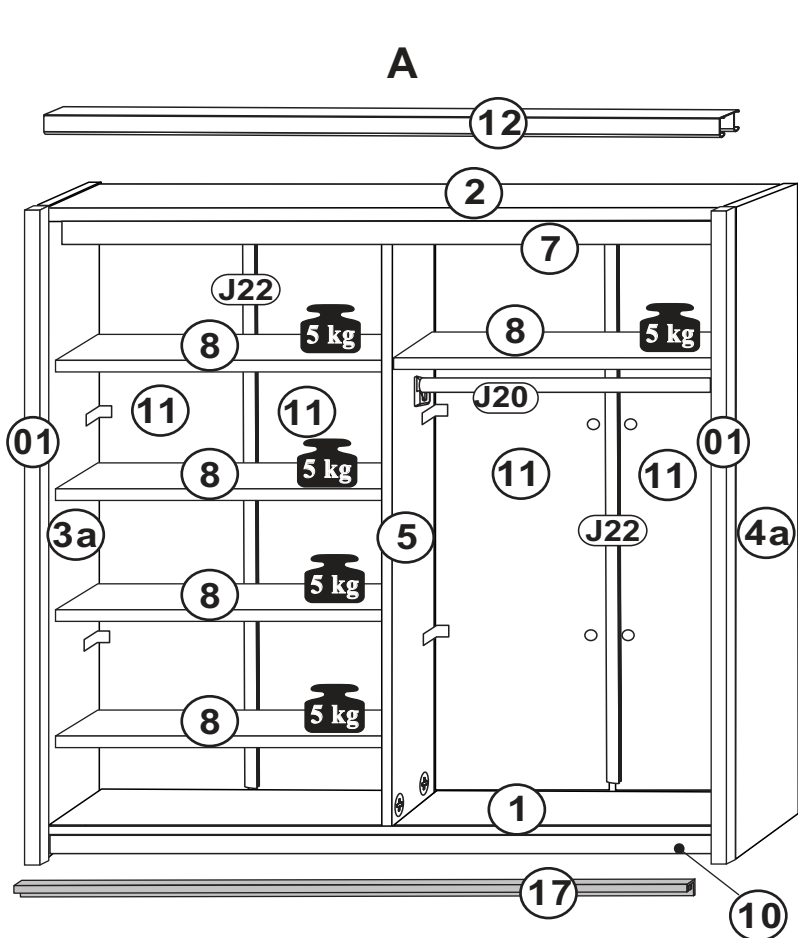

C

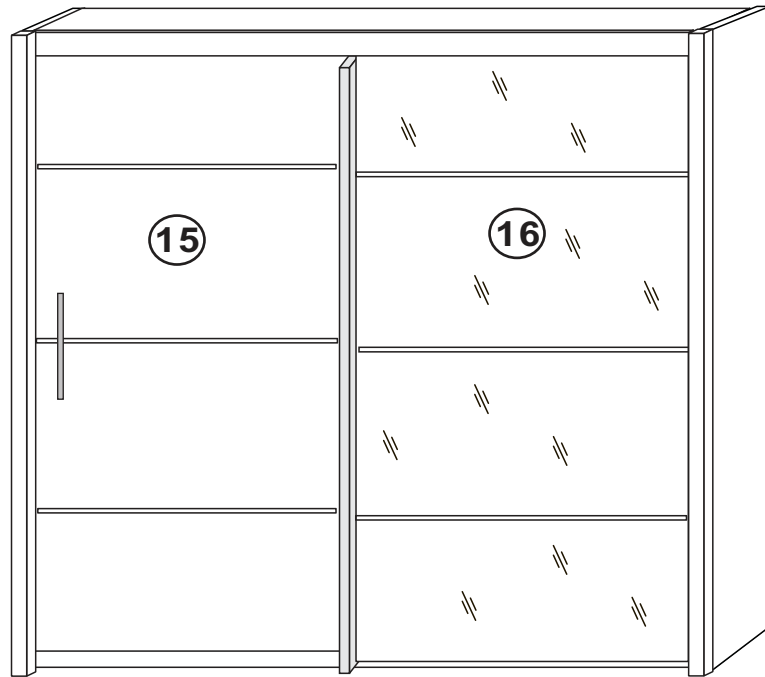

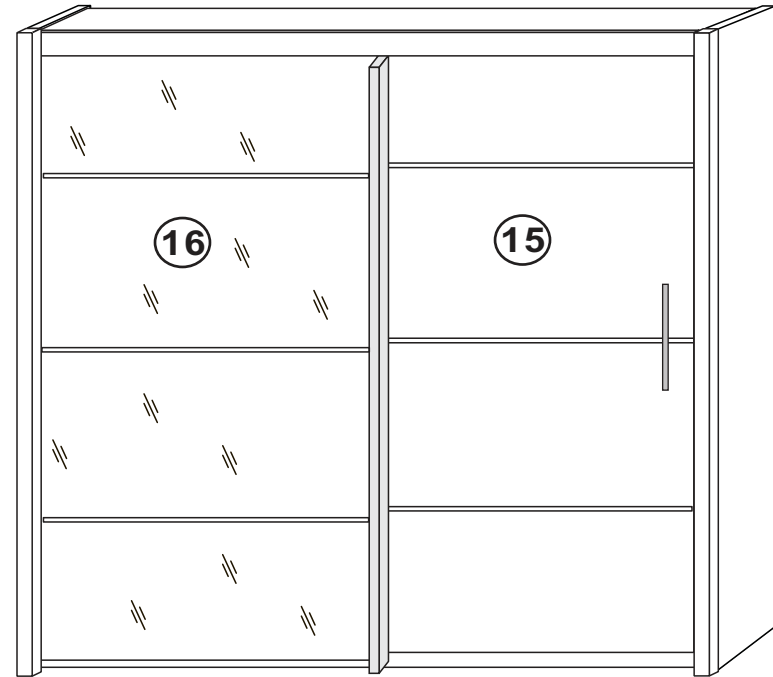

D

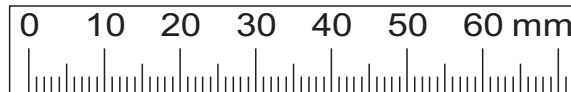
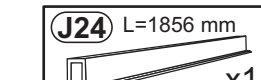
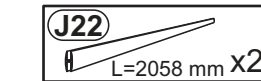
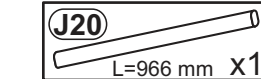
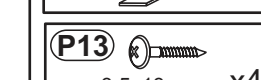
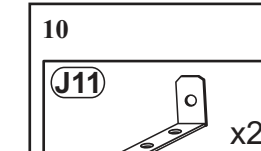
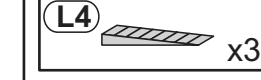
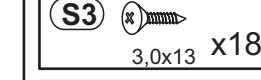
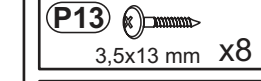
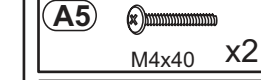
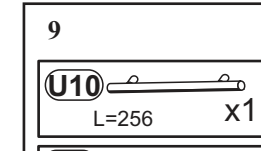
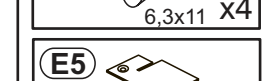
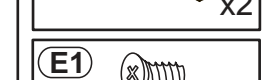
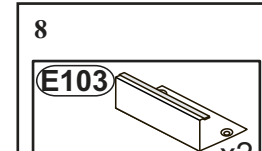
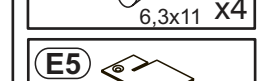
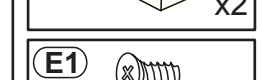
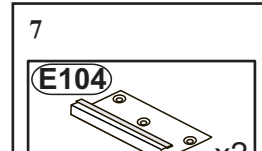
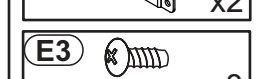
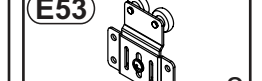
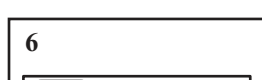
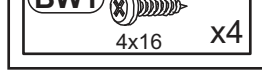
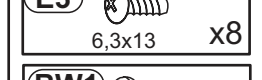
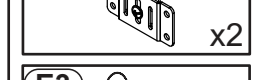
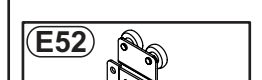
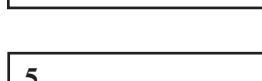
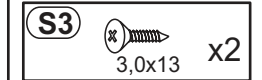
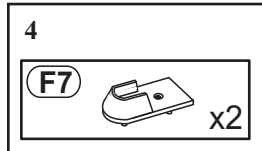
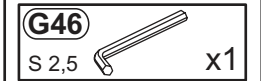
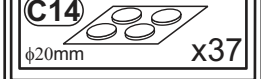
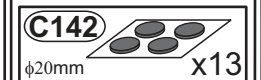
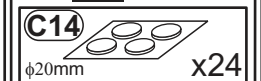
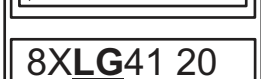
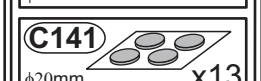
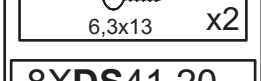
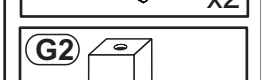
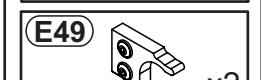
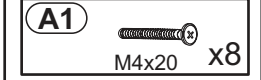
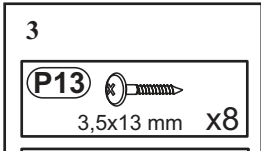
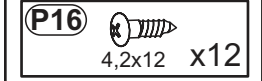
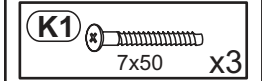
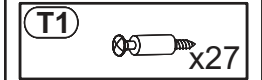
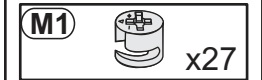
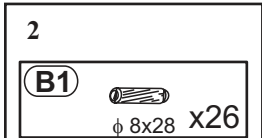
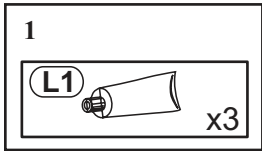



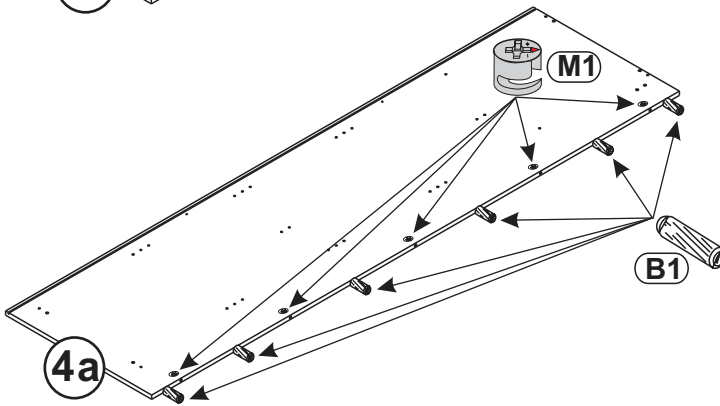
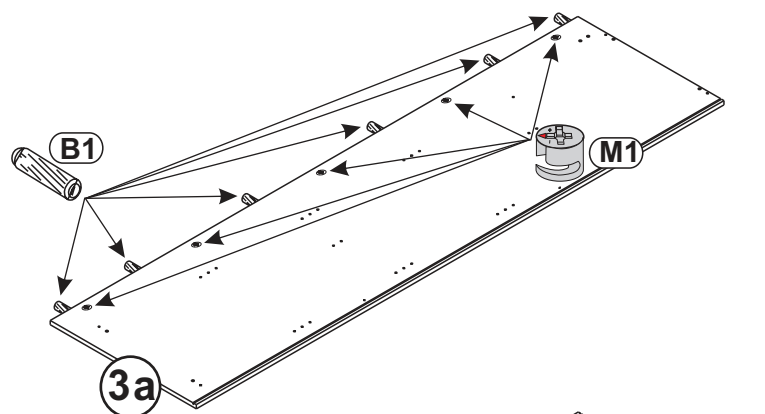
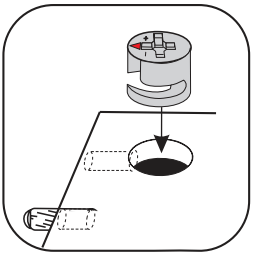
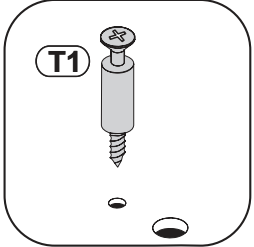
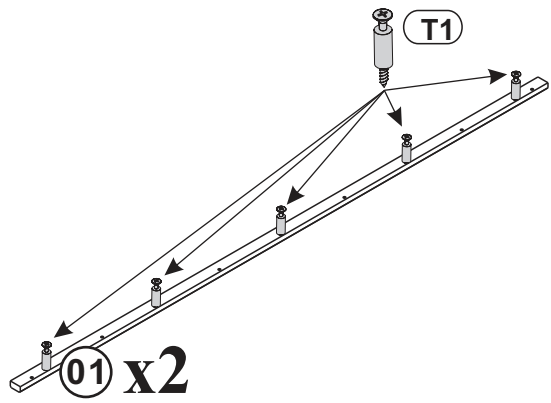

1

- B1**  $\phi 8 \times 28$ x12
- M1**  x10
- T1**  x10



2

- 8XDS41 20**
C141  $\phi 20$ mm x10





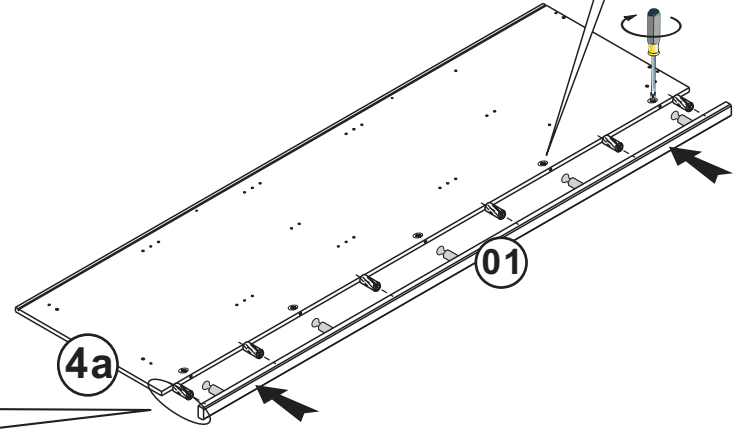
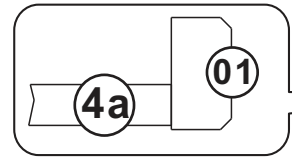
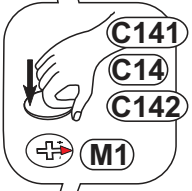
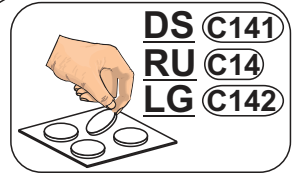
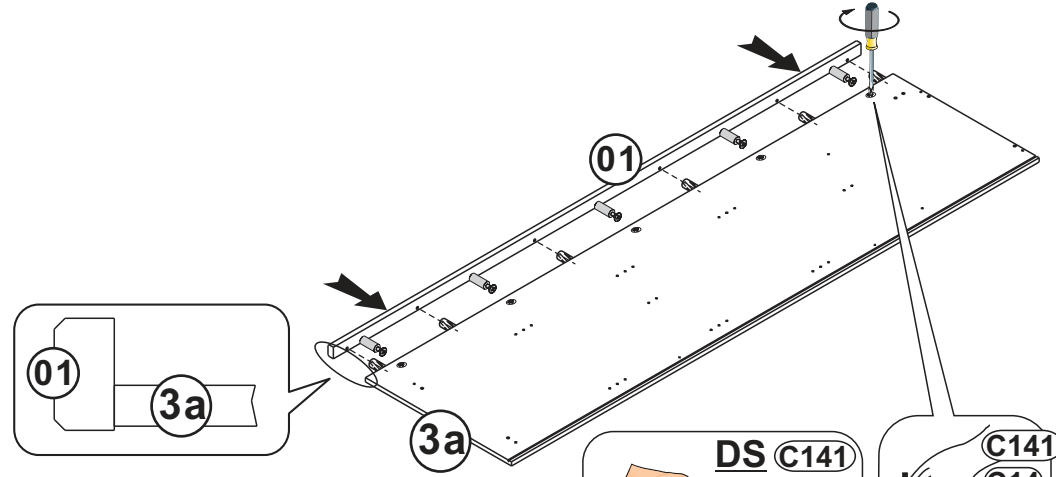

- 8XRU41 20**
C14  $\phi 20$ mm x10

- 8XLG41 20**
C142  $\phi 20$ mm x10



3

A 

G10  x8	T1  x8	F7  x2	B1  x4 φ 8x28
W8  x20	S3  x2 3.0x13	M1  x4	

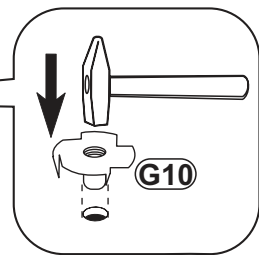
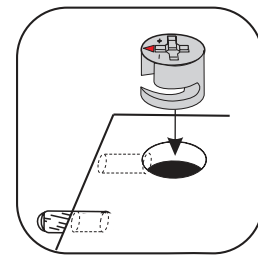
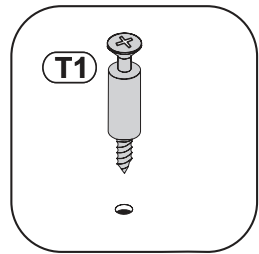
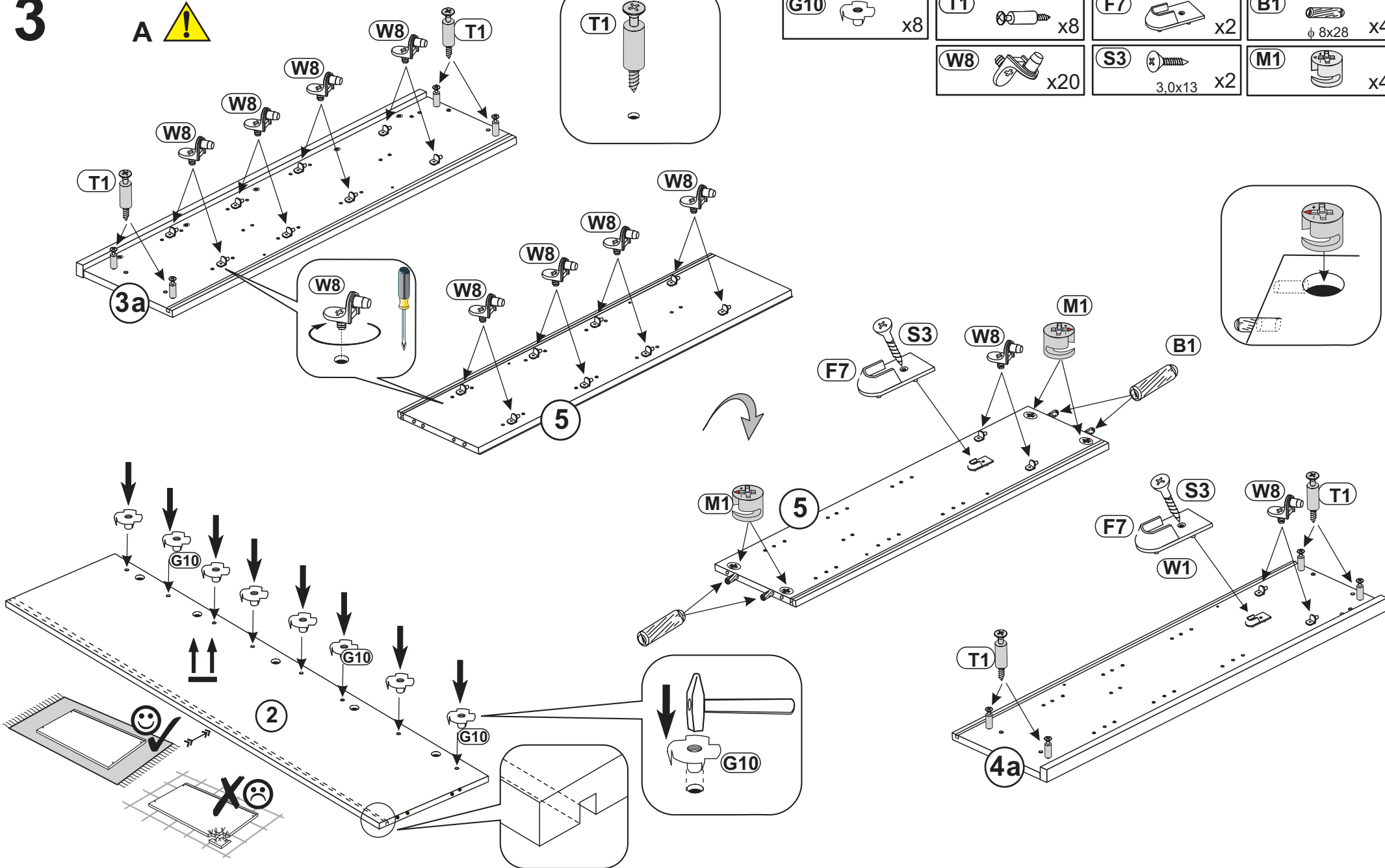

4

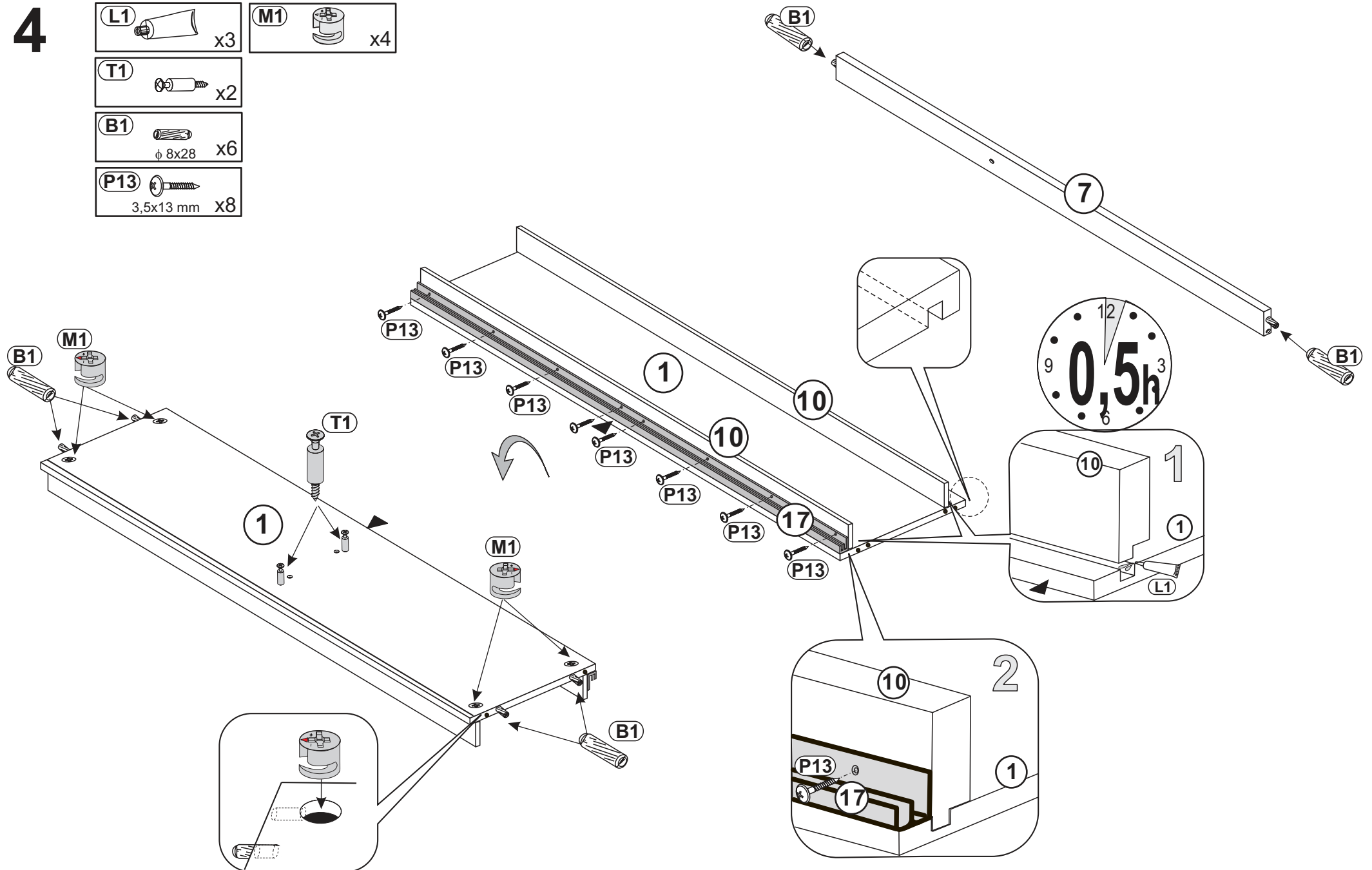
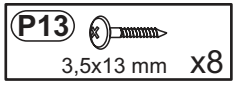
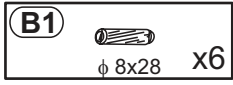
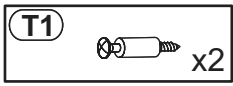
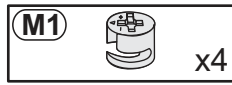
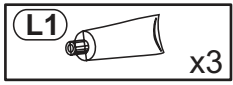



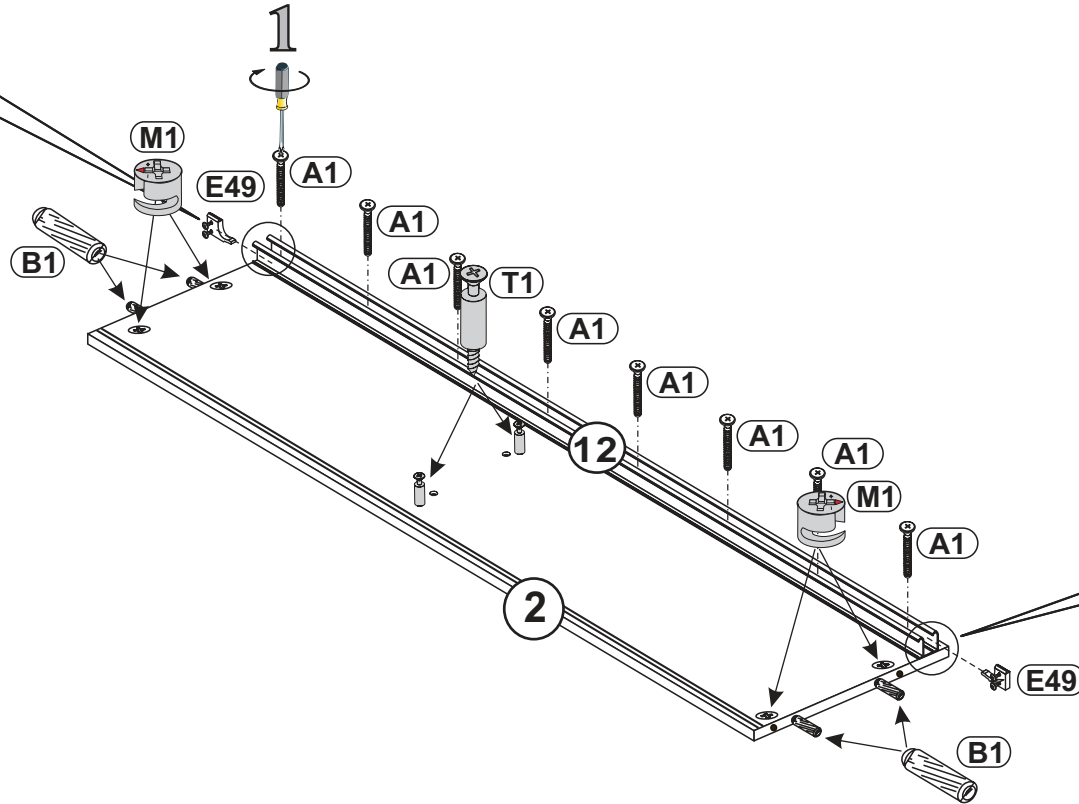
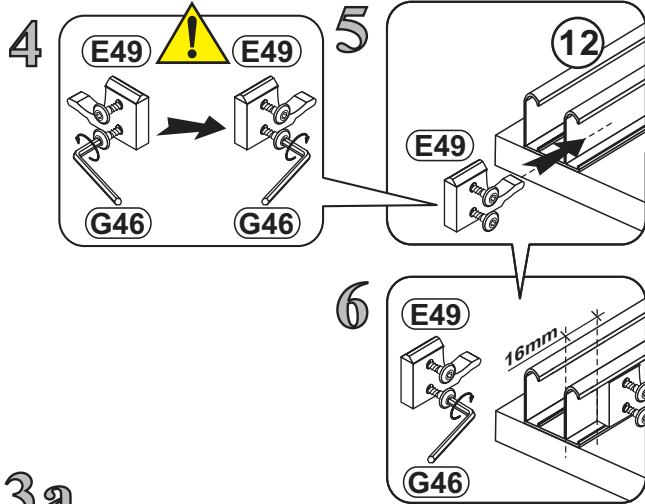
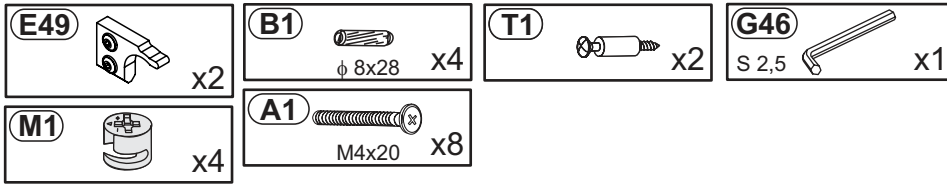

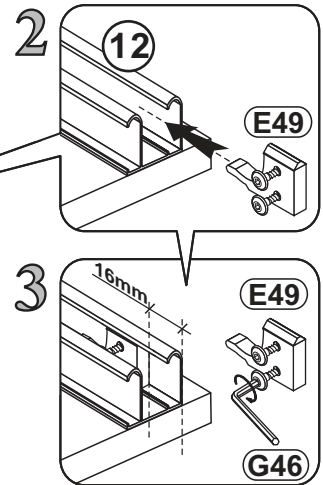
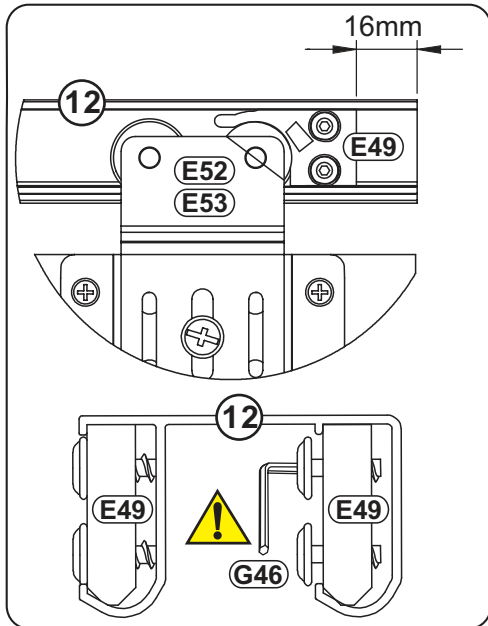

5a



3a



5b

- E49**  x2
- B1**  ϕ 8x28 x4
- T1**  x2
- G46**  S 2,5 x1
- M1**  x4
- A1**  M4x20 x8

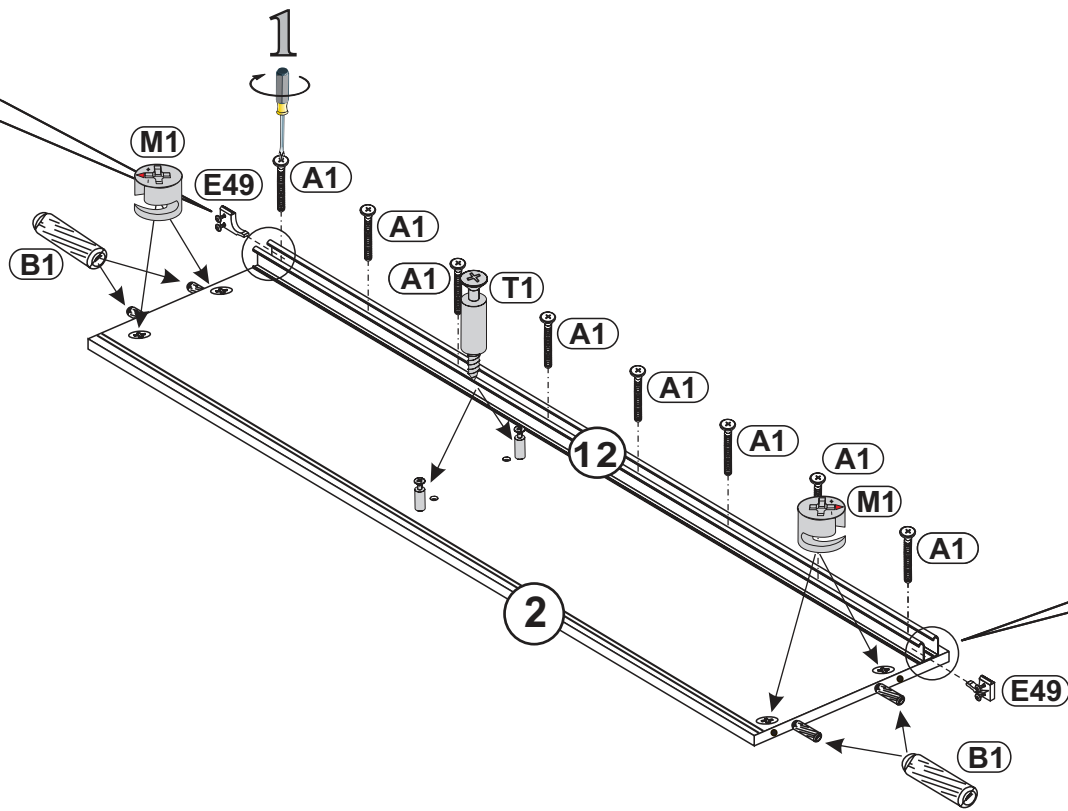
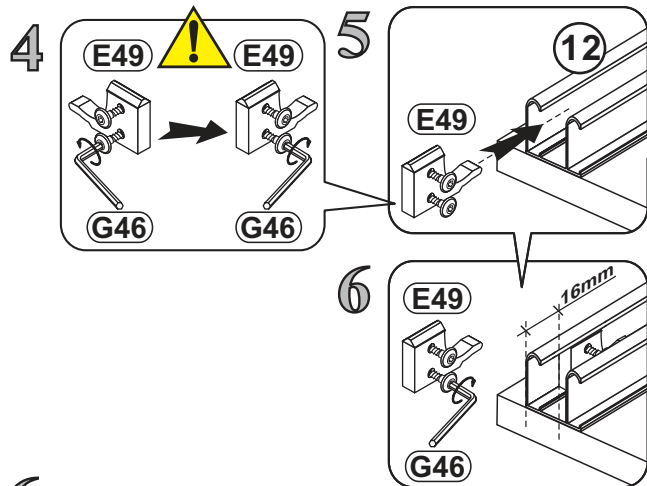

6a

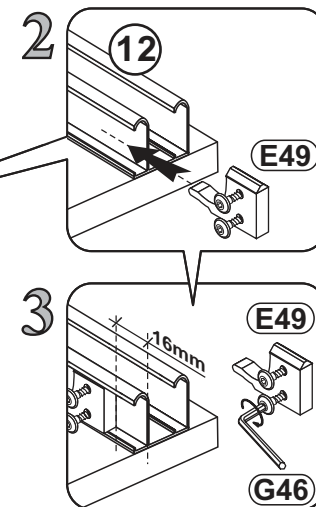
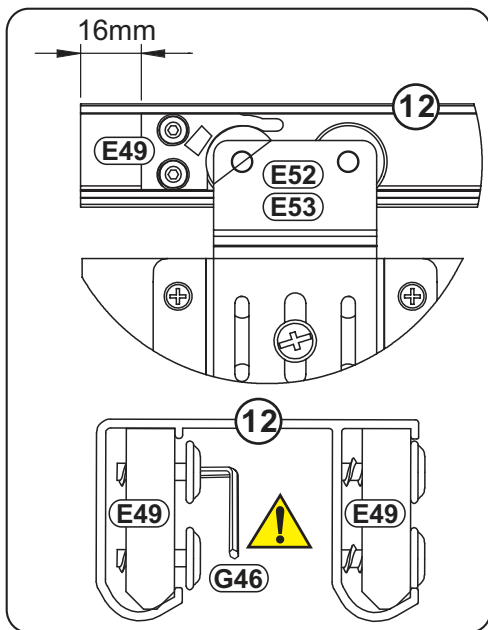

6

A 

- | | |
|----------------------------|---|
| K1
7x50 x2 | M6
 x4 |
| J22
L=2058 mm X1 | P16
4,2x12 x4 |

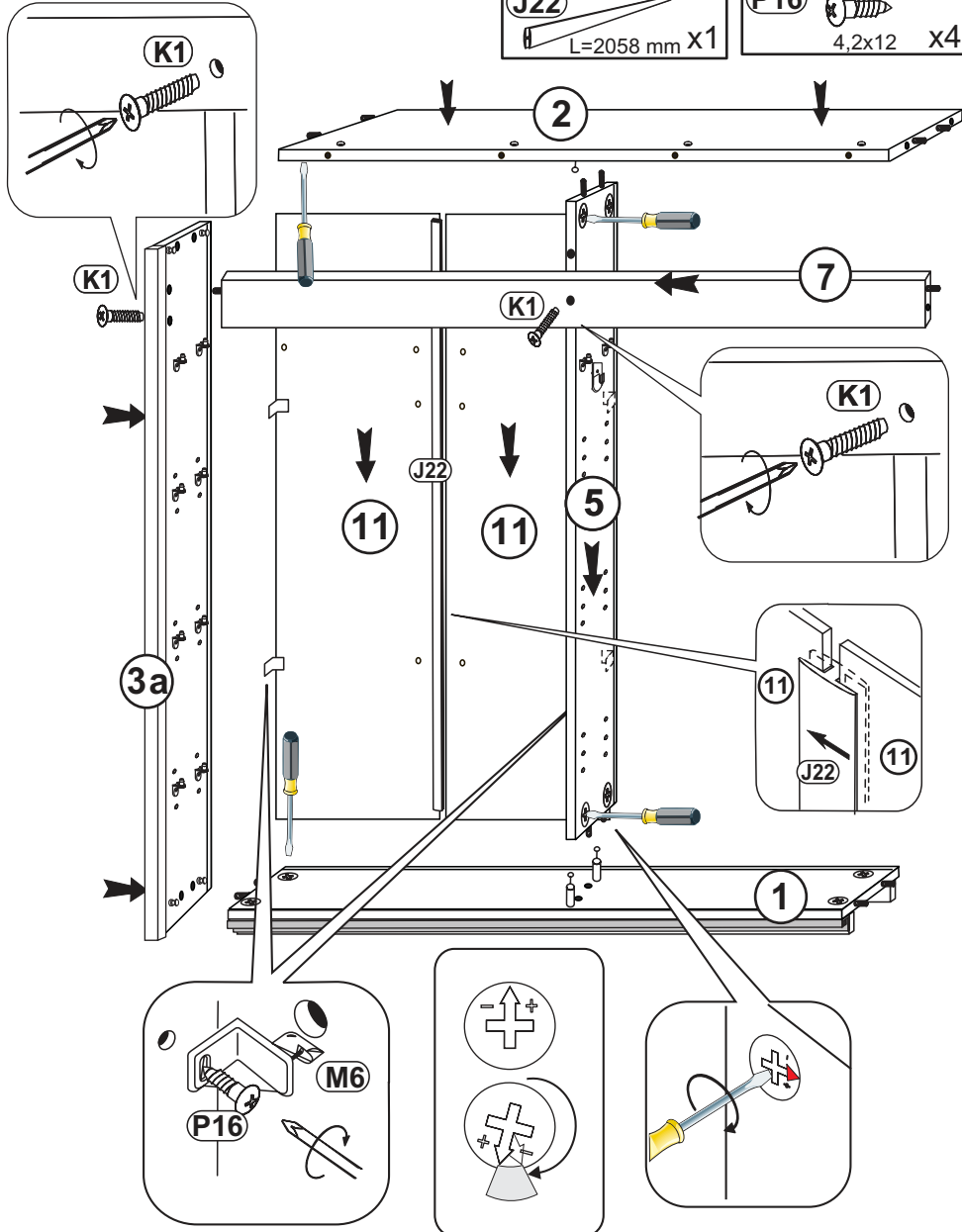

7

- | | |
|----------------------------|---|
| K1
7x50 x1 | P16
4,2x12 x4 |
| J22
L=2058 mm X1 | M6
 x4 |

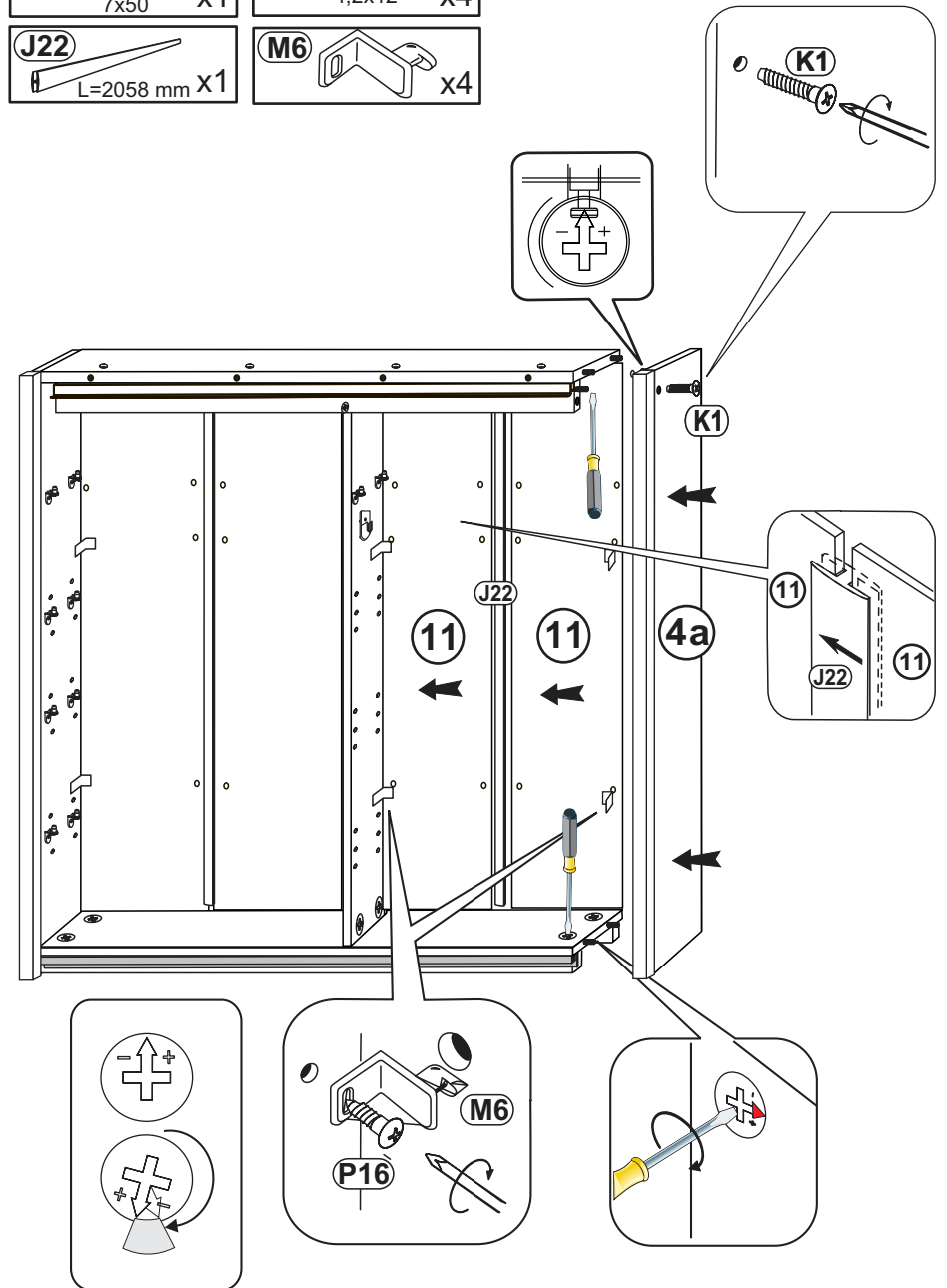

8

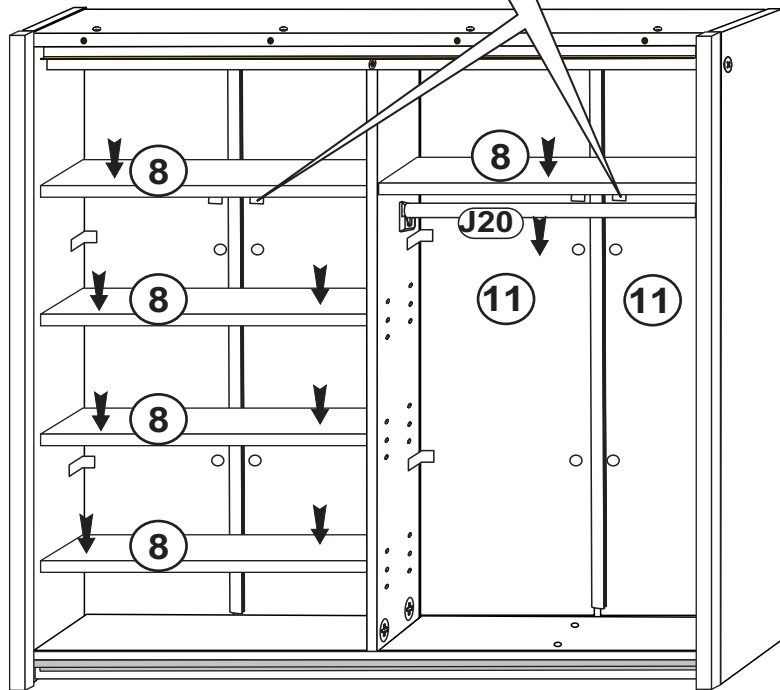
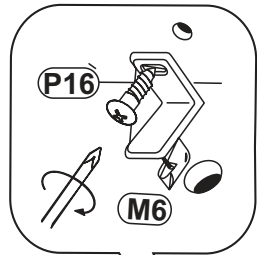
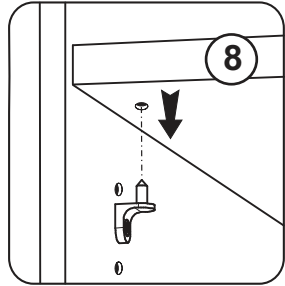
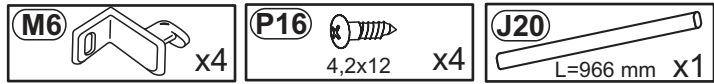

9

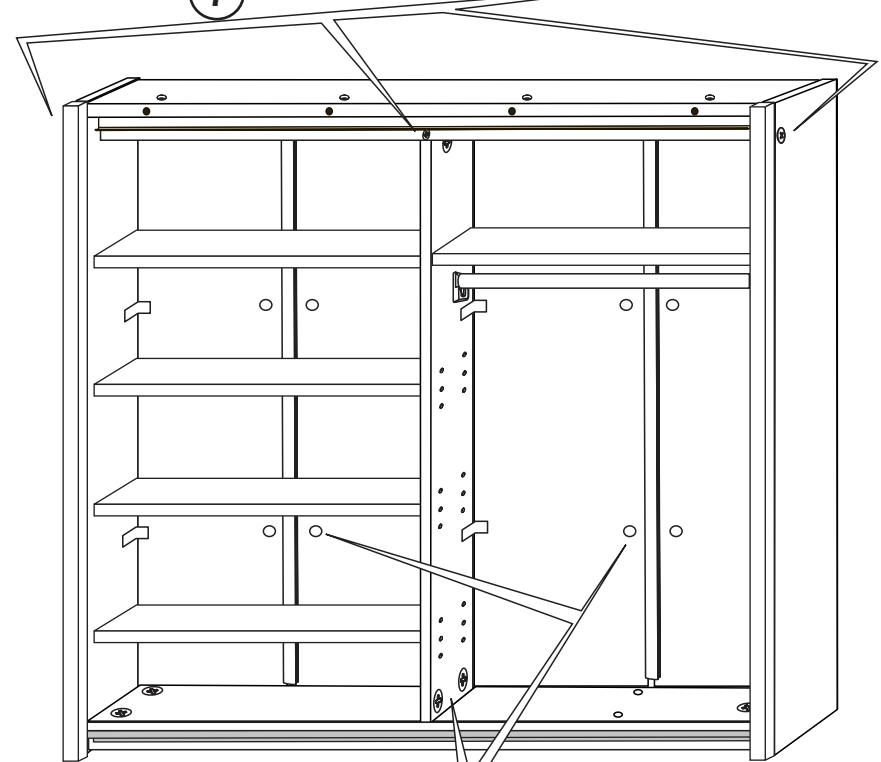
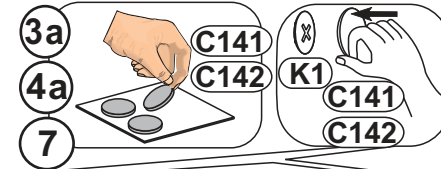
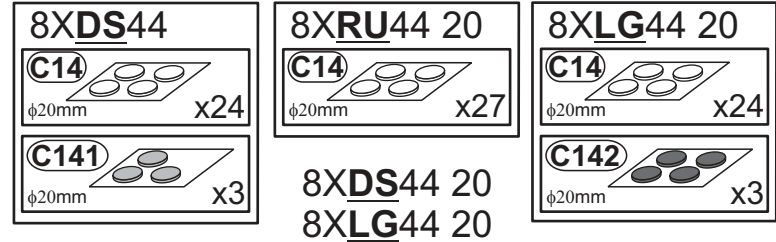

10

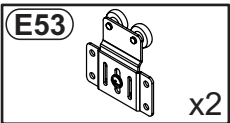

C

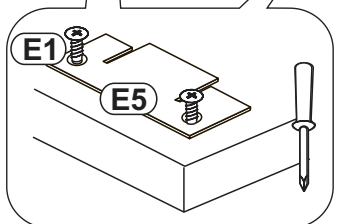
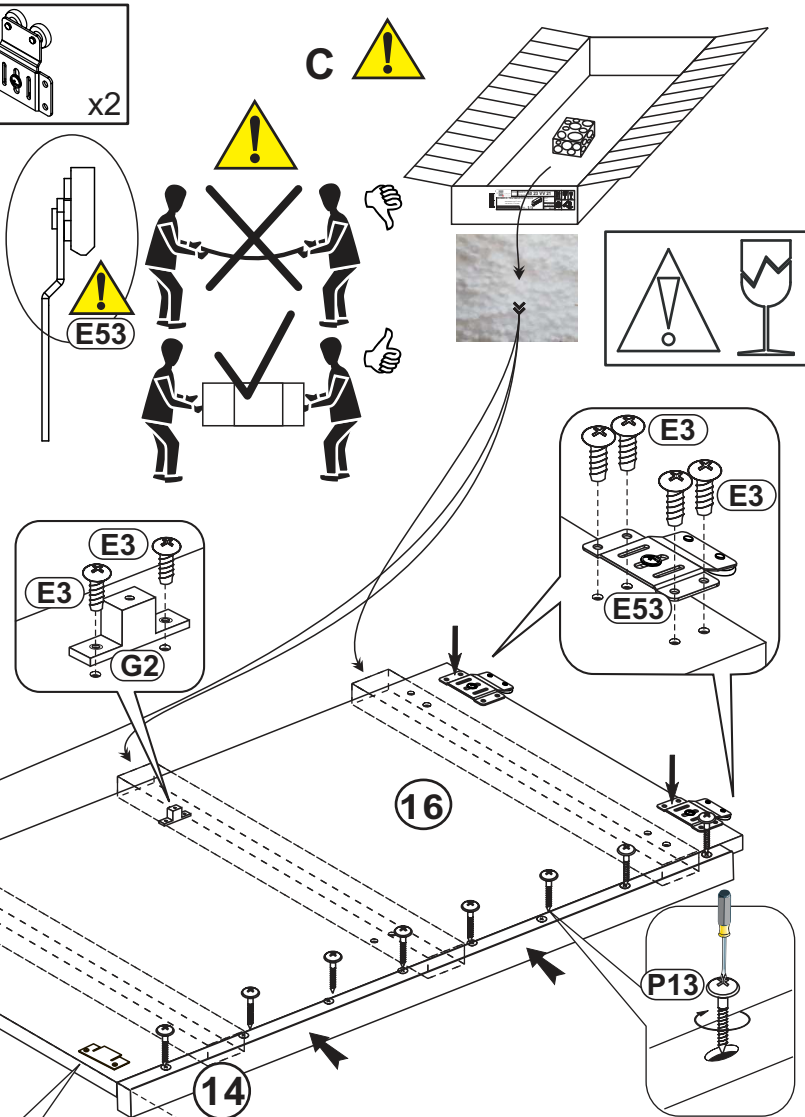
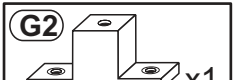
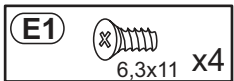
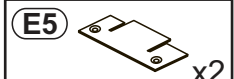
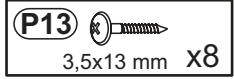

11

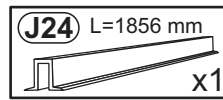

C

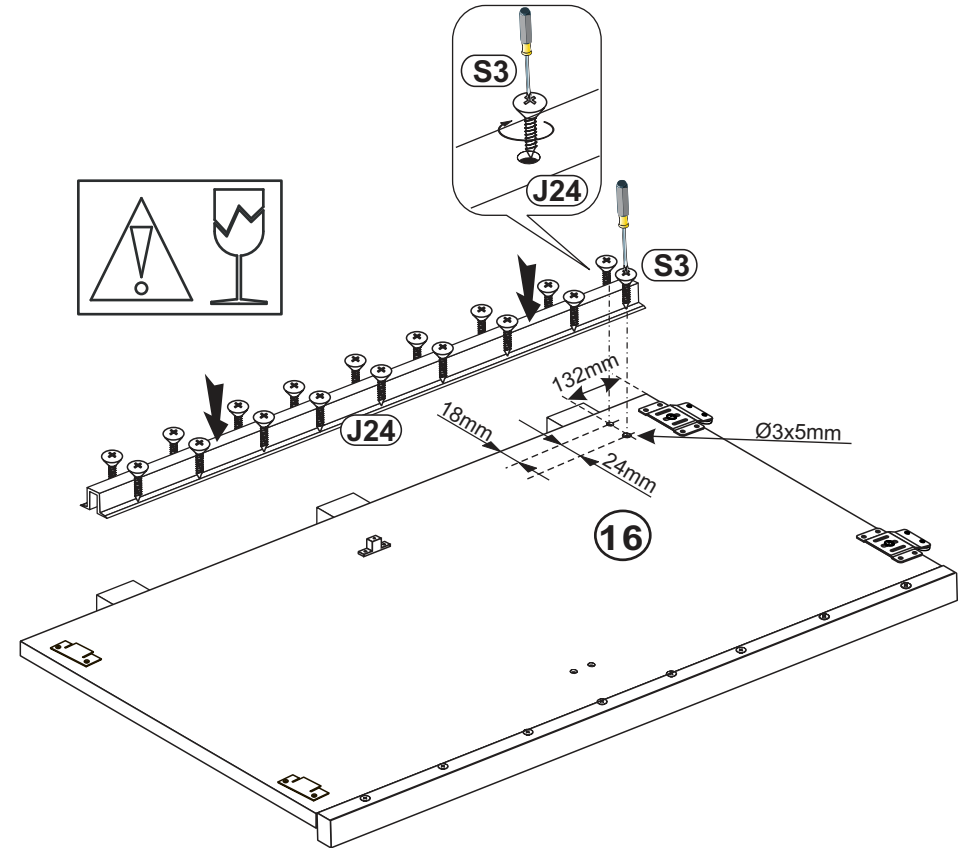
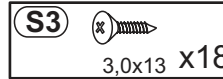

12

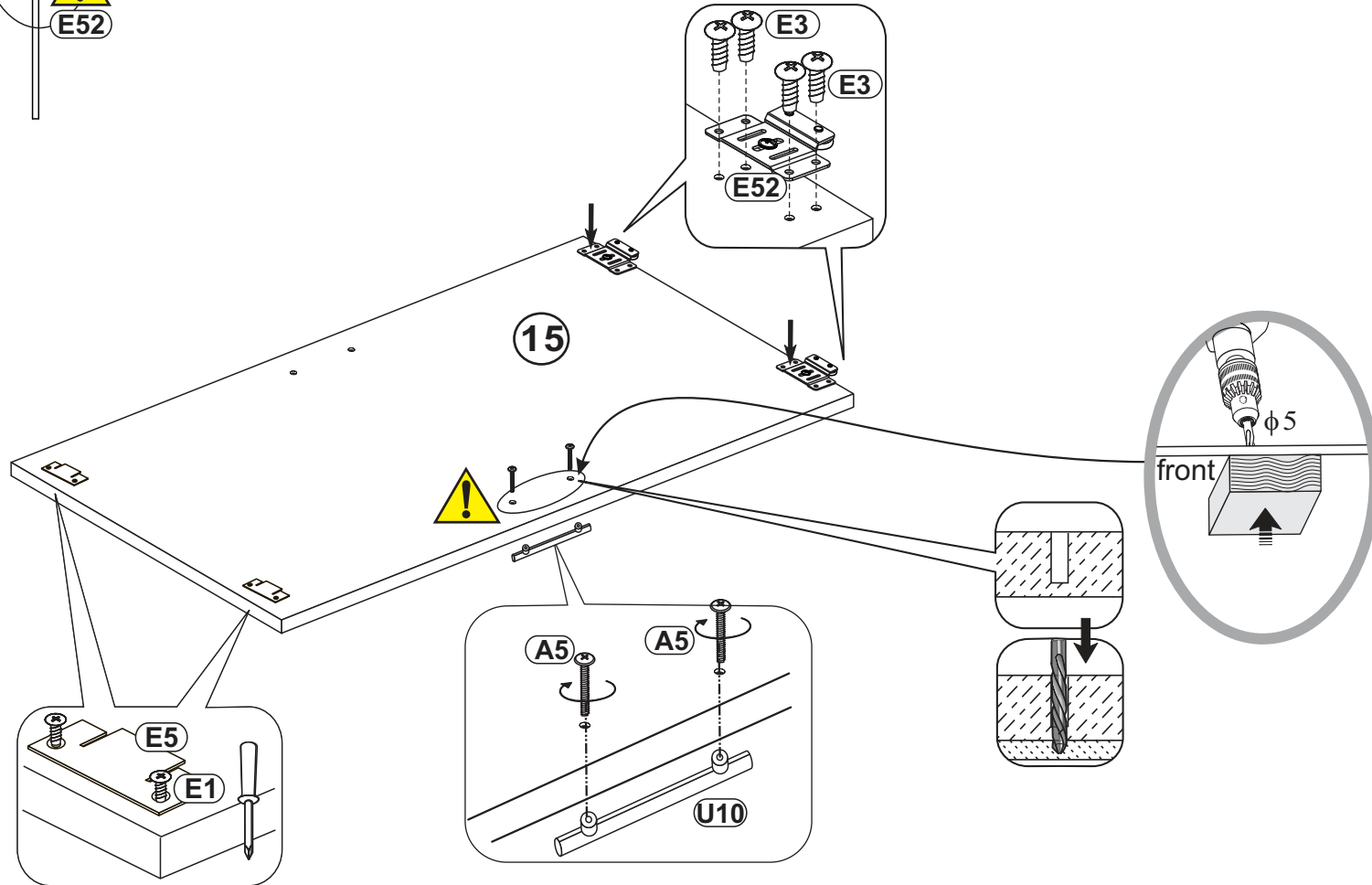
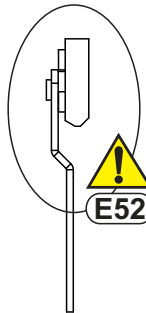
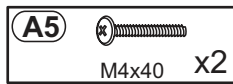
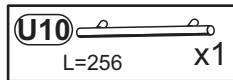
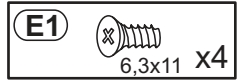
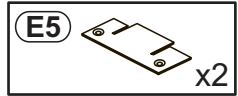
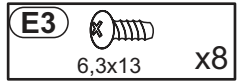
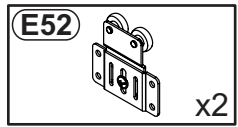

13

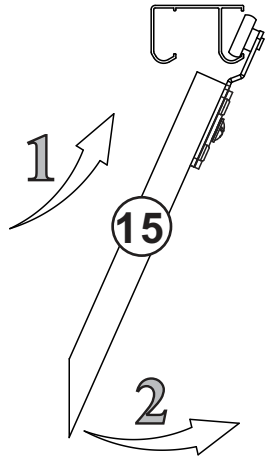
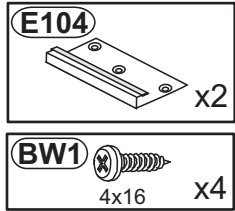

c

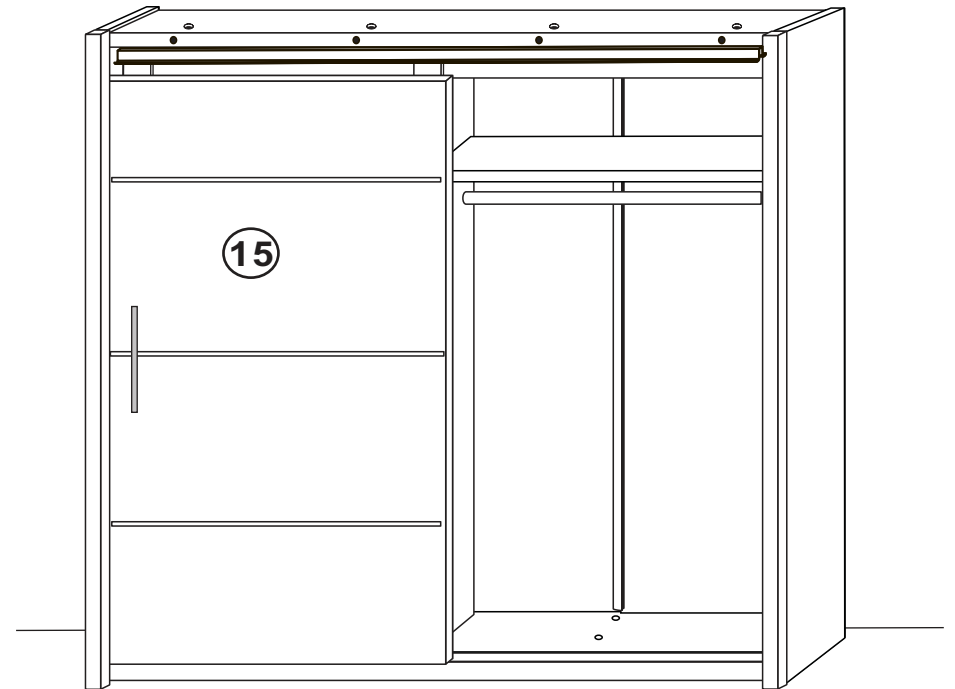
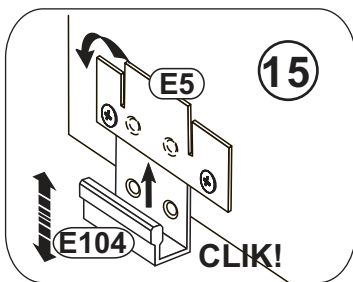
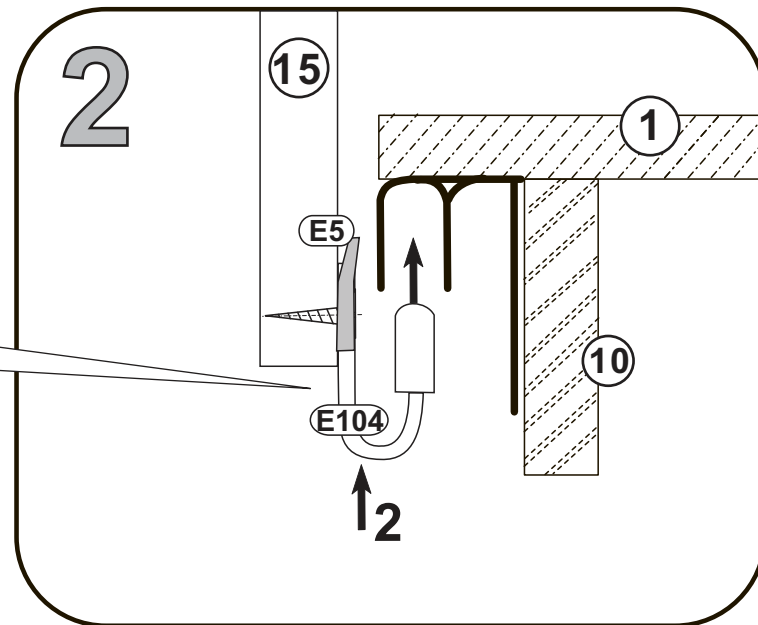
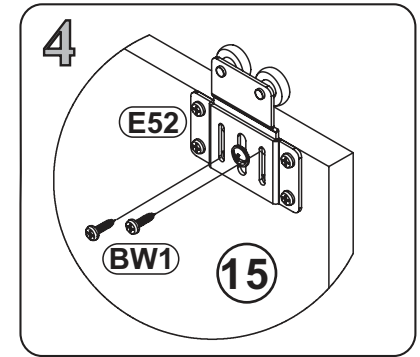
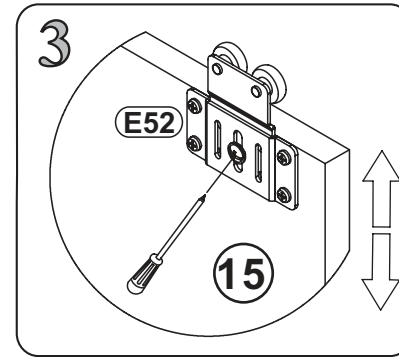
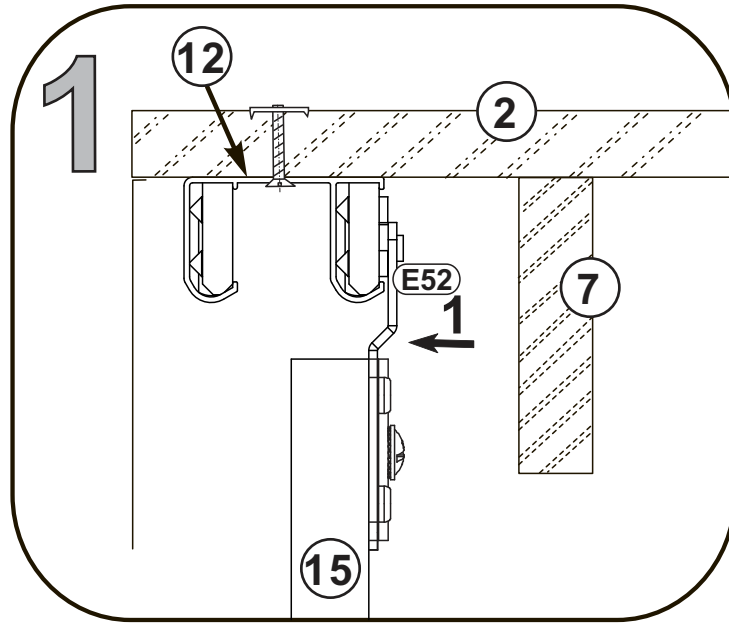

14

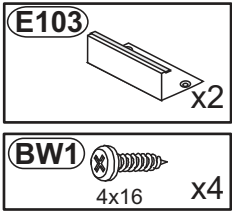

c

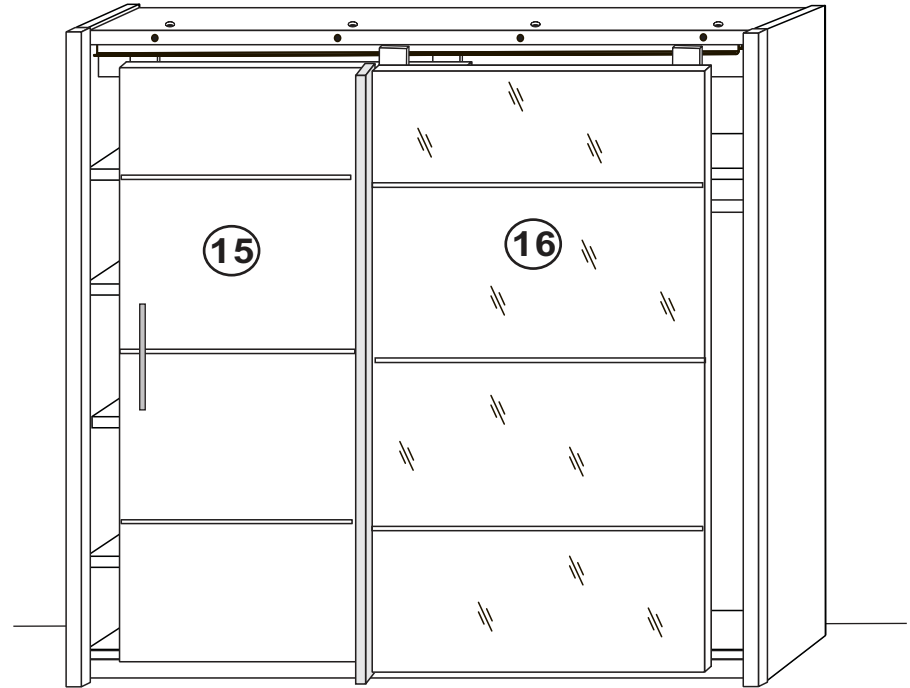
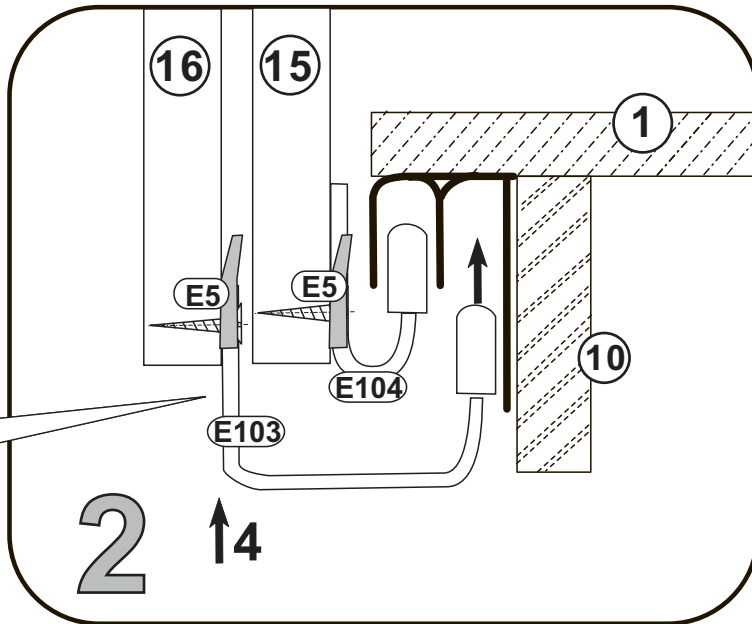
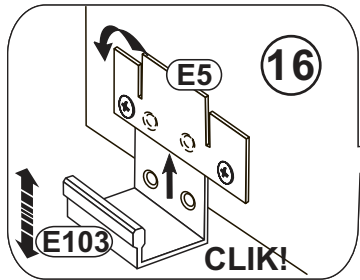
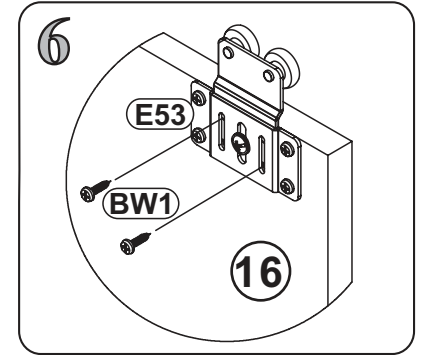
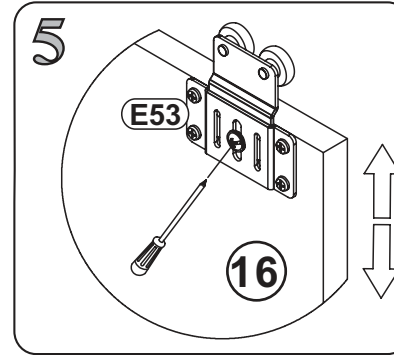
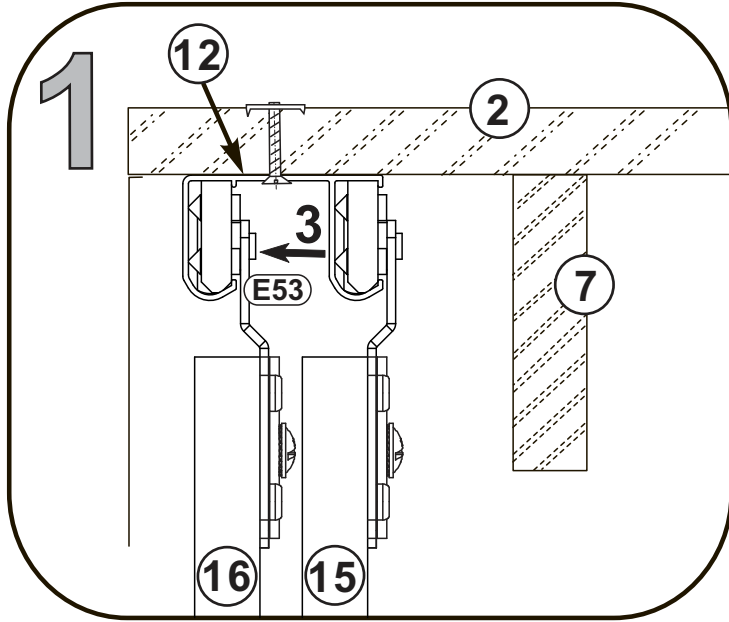
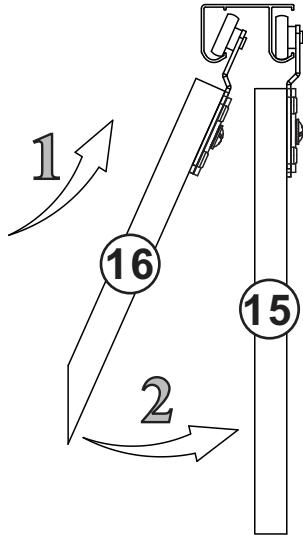

15

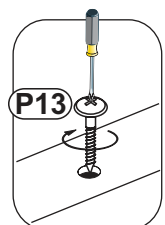
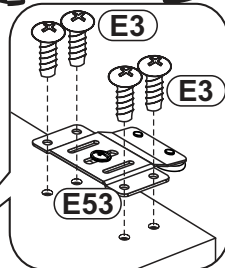
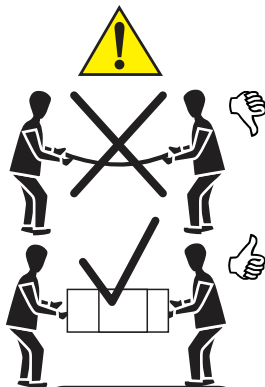
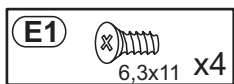
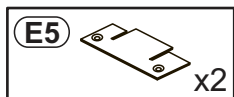
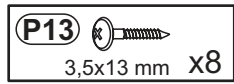
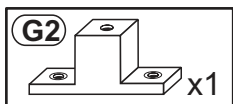
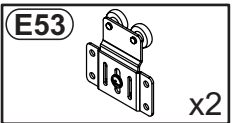

16

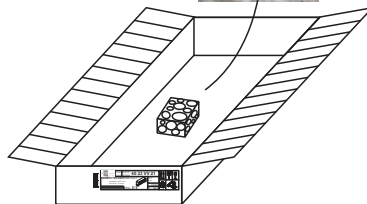
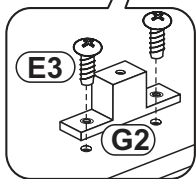
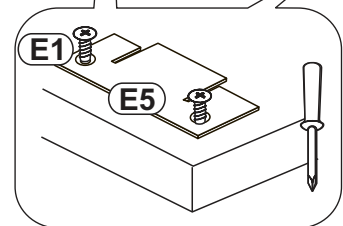

16

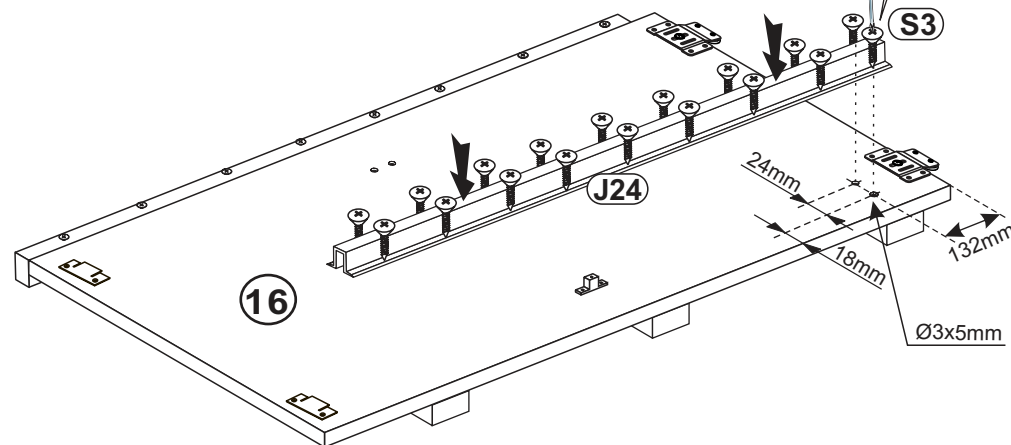
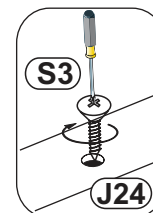
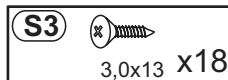
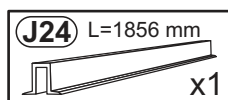

17

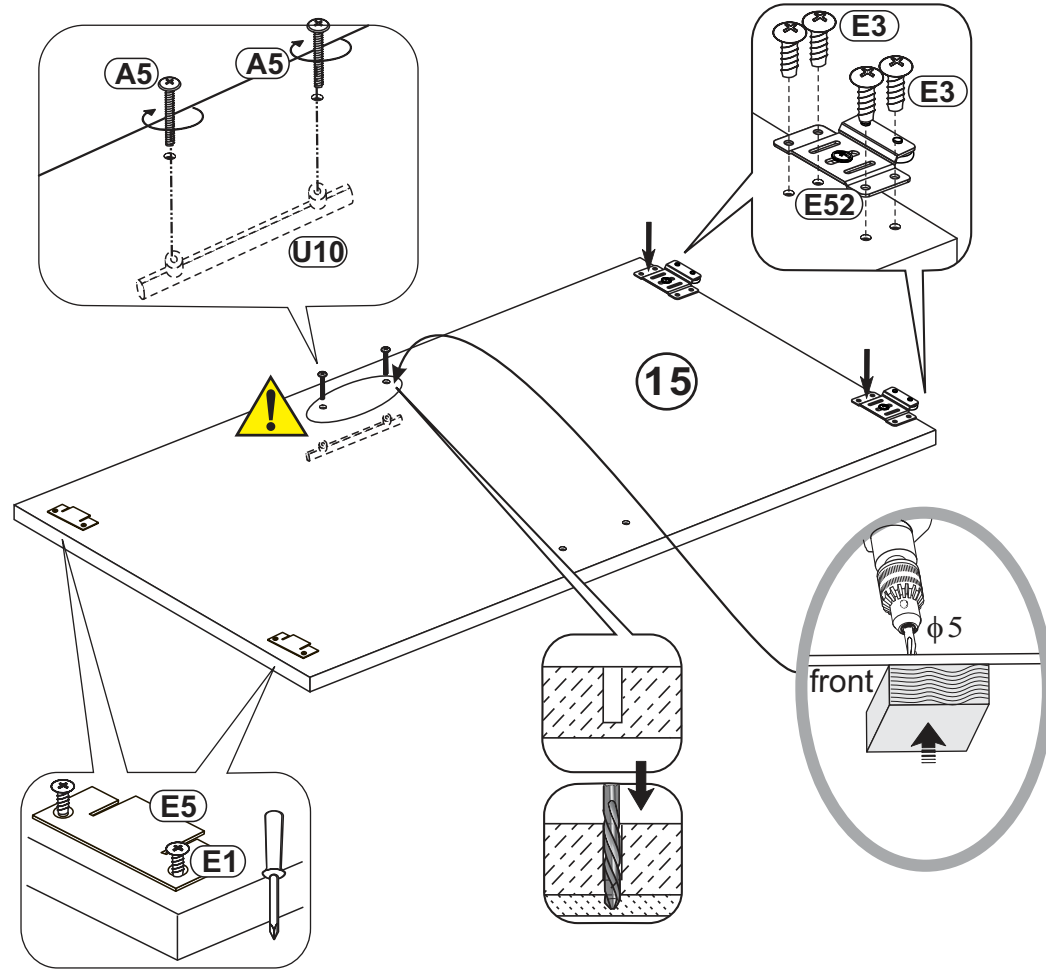
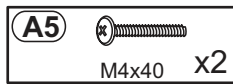
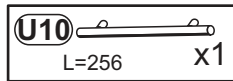
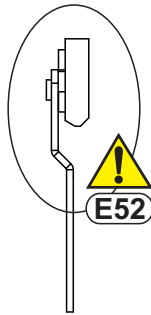
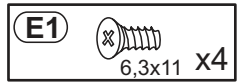
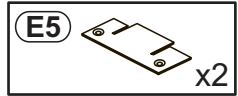
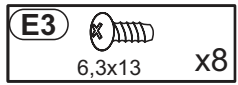
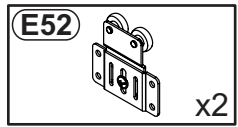

18

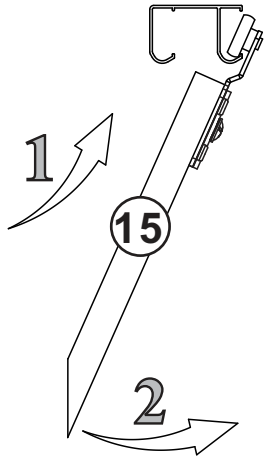
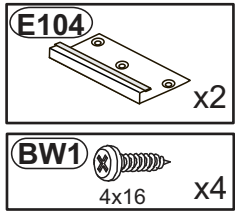

D

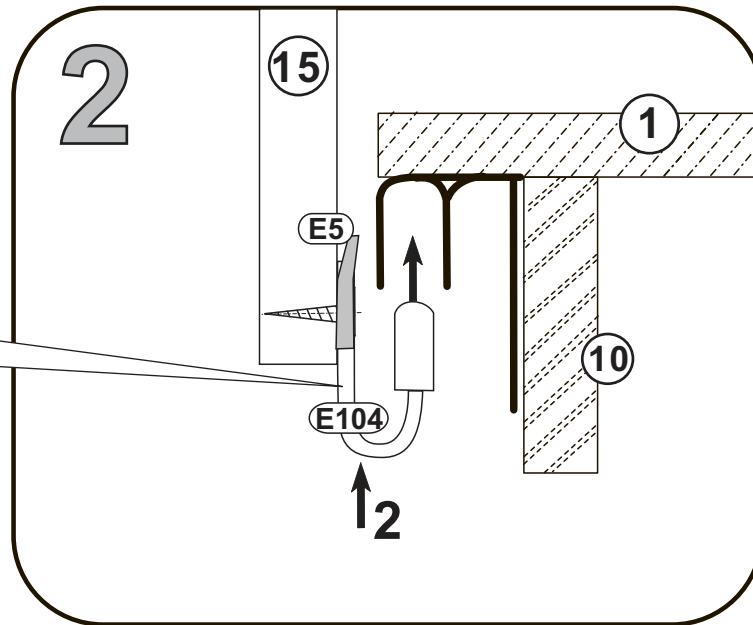
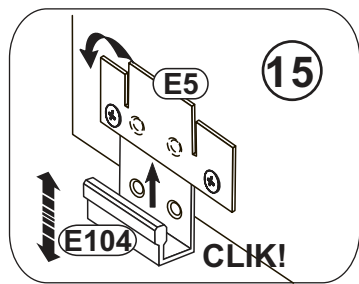
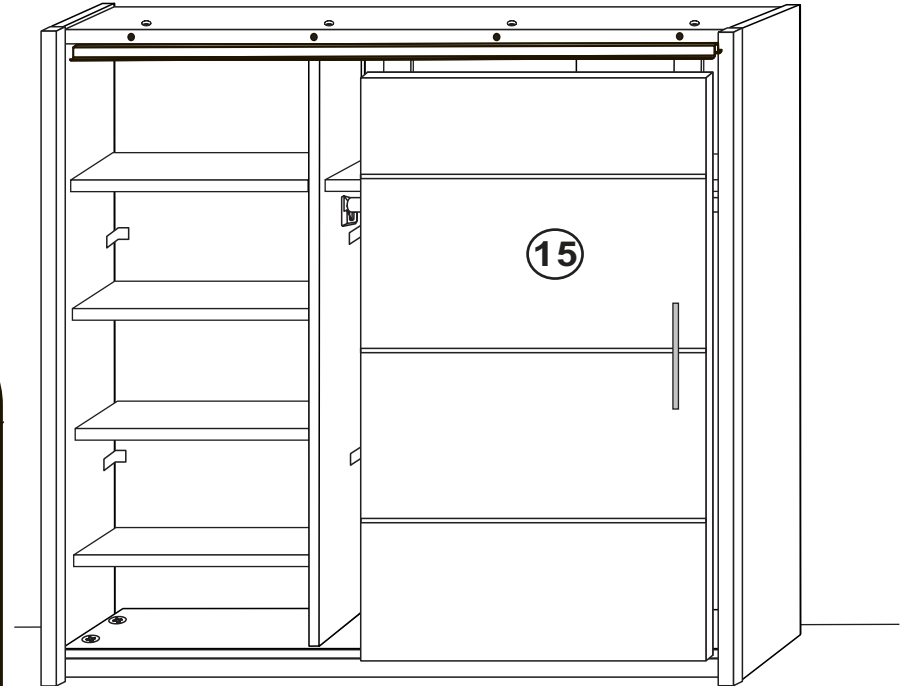
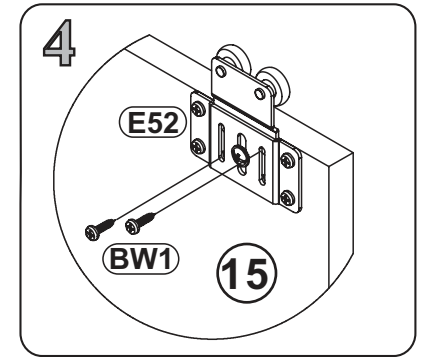
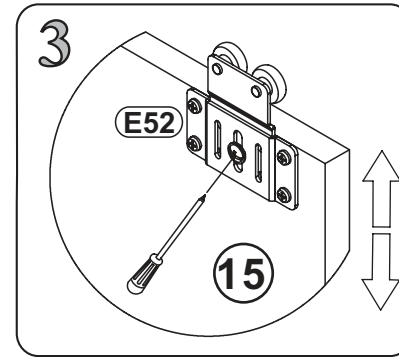
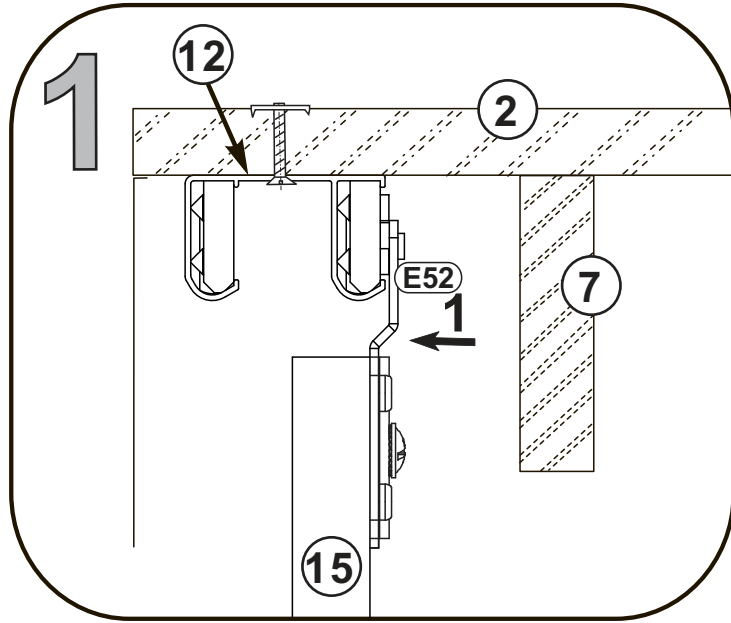

19

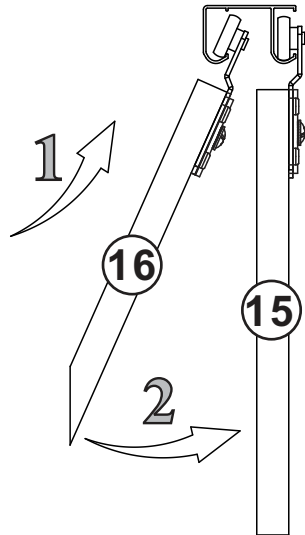
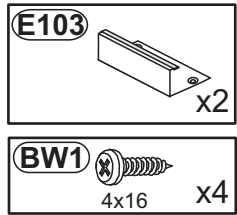

D

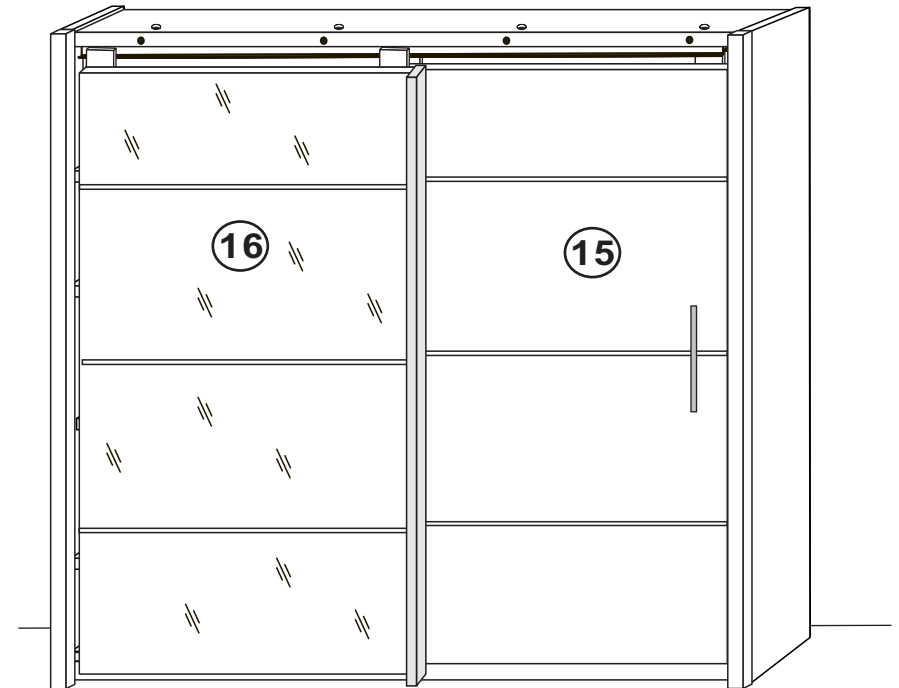
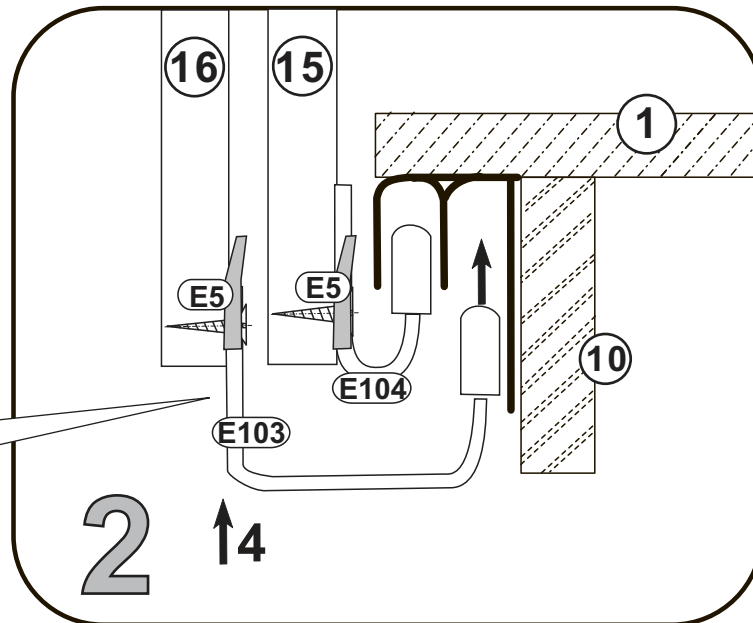
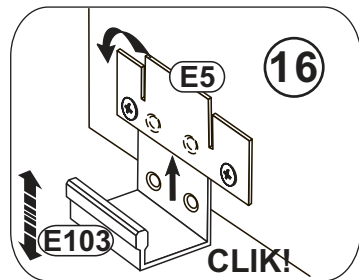
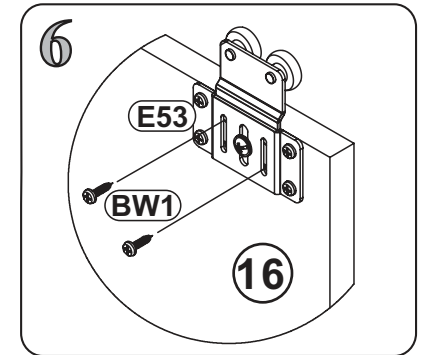
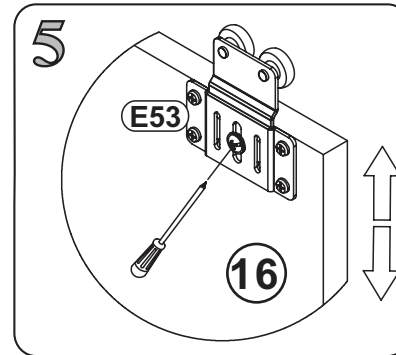
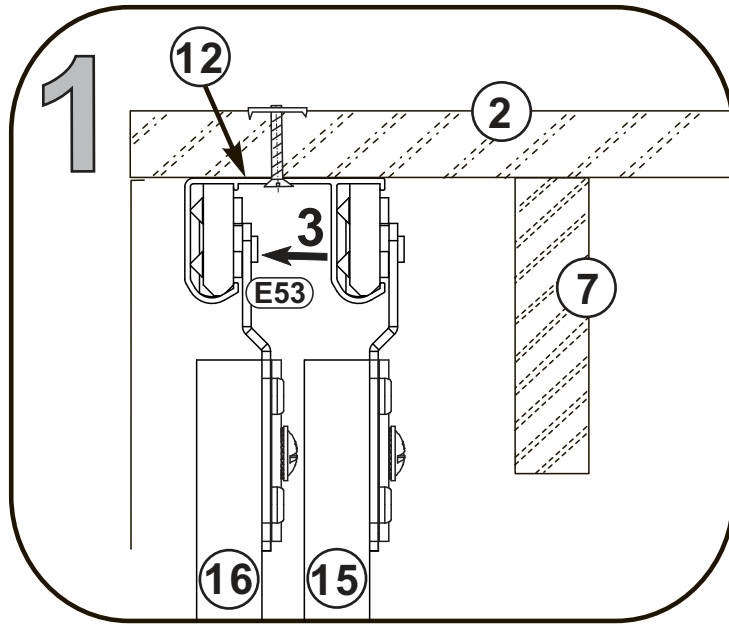

20

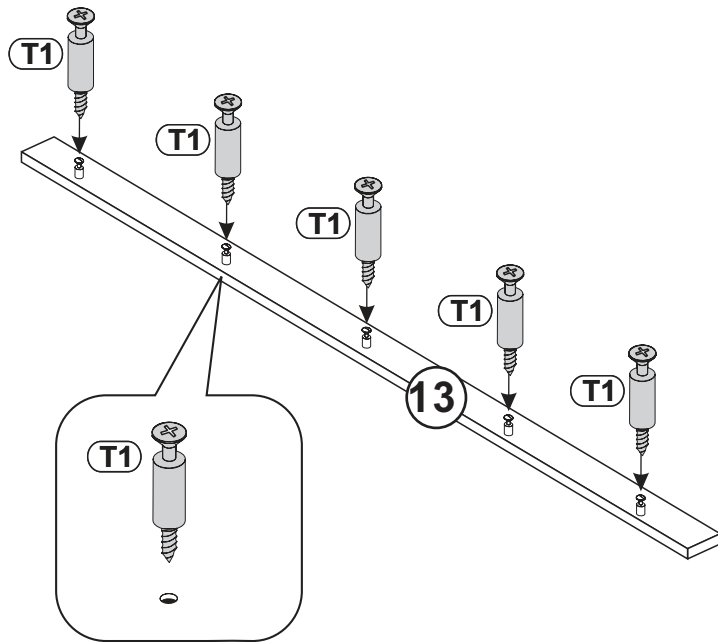
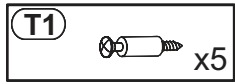

21

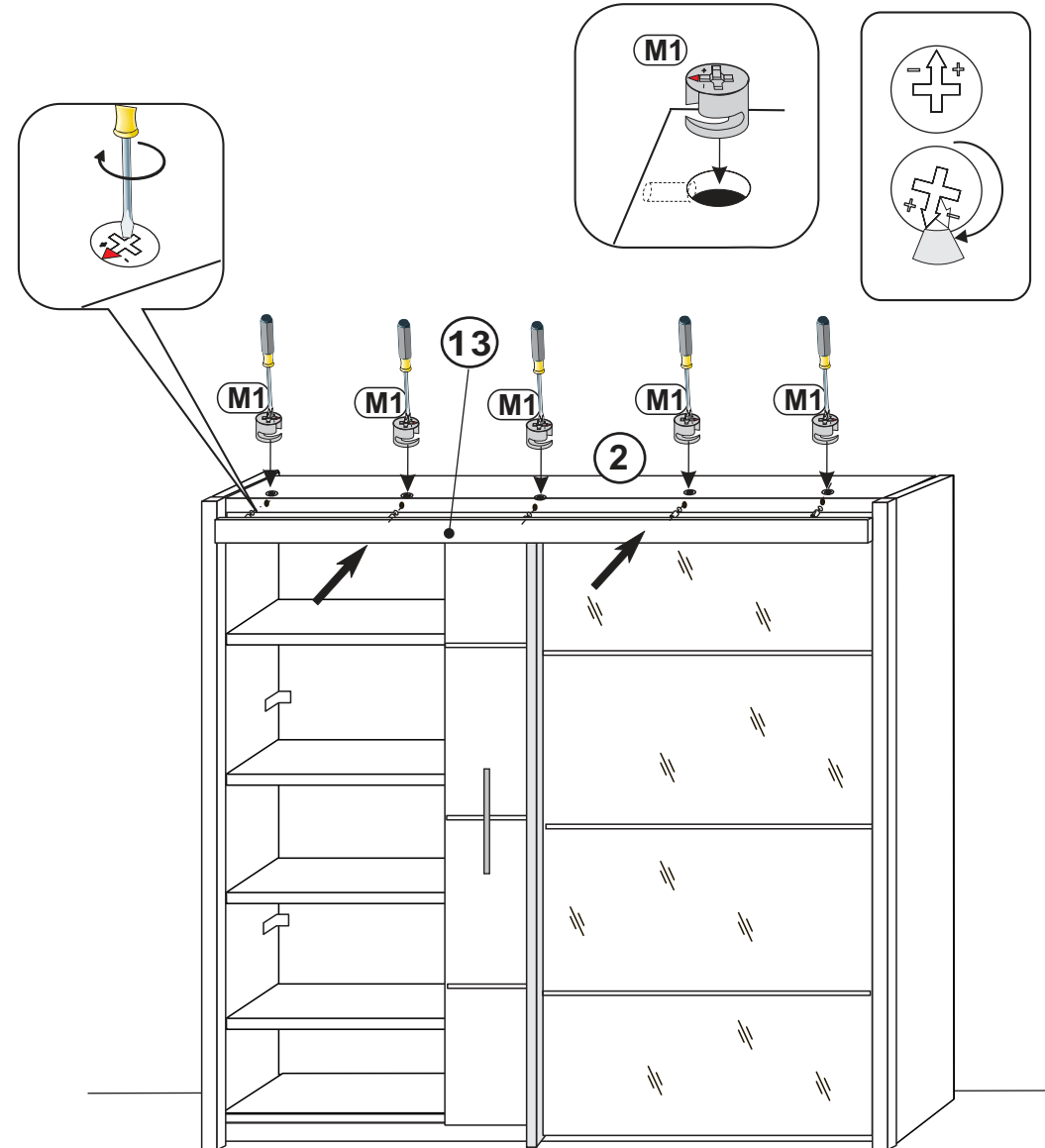
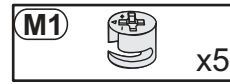

22

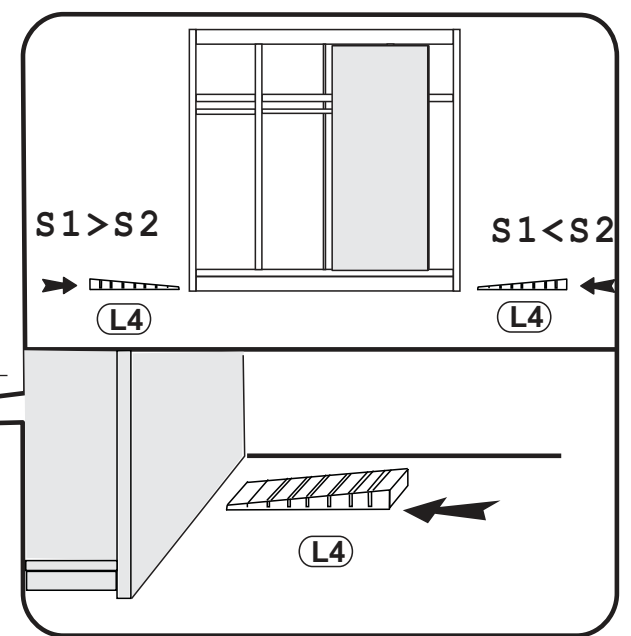
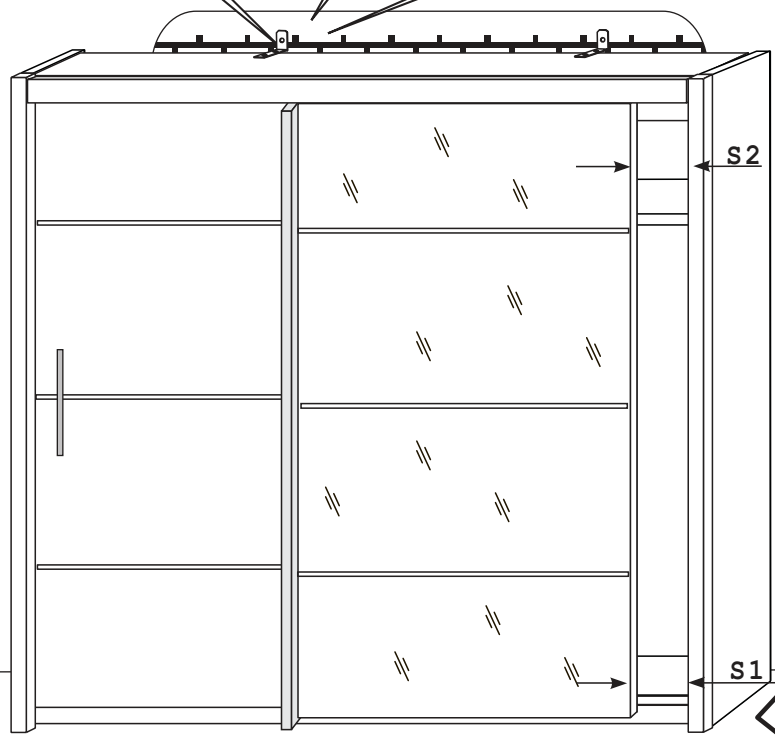
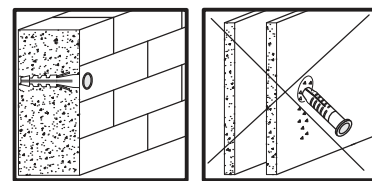
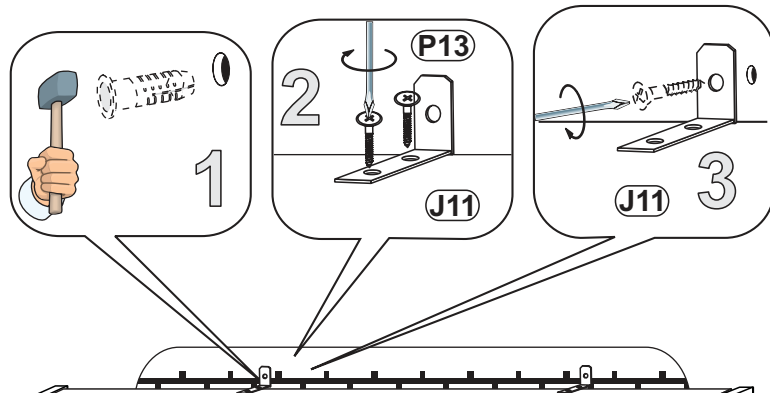
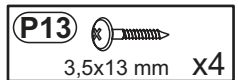
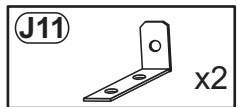
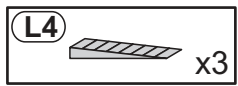



DE	<p>Warnhinweis:</p> <p>Wenn der Ware Dübel und Schrauben beiliegen, sind sie ausschließlich zur Anwendung an Wänden aus massiven und einheitlichen Materialien bestimmt, um ein Umkippen zu verhindern. Vergewissern Sie sich vor dem Bohren, dass sich keine Gas-, Wasser-, oder Stromleitungen an der Bohrstelle befinden. Zur Befestigung an anderen Wänden müssen Spezialdübel verwendet werden. Erkundigen Sie sich im Handel nach für die jeweilige Wandbeschaffenheit geeigneten Schrauben und oder Dübel. Für eine unsachgemäße Montage und dadurch entstandene Schäden übernimmt der Hersteller keine Haftung. Bitte alle Schrauben in regelmäßigen Abständen überprüfen und nachziehen.</p>
FR	<p>Avertissement :</p> <p>Pour éviter le basculement accidentel du meuble, la fixation du meuble au mur rest obligatoire.</p> <p>Si des chevilles et des vis sont fournies avec l'article, elles sont exclusivement destinées à être utilisées sur des murs en matériaux massifs et homogènes pour éviter tout basculement. Avant de percer, assurez-vous qu'aucune conduite de gaz, d'eau ou d'électricité ne se trouve à l'endroit où vous percez. Pour la fixation sur d'autres murs, il faut utiliser des chevilles spéciales. Renseignez-vous en magasin sur les vis et les chevilles adaptées à chaque type de mur. Le fabricant décline toute responsabilité en cas de montage incorrect et de dommages qui en résulteraient. Veuillez vérifier et resserrer toutes les vis à intervalles réguliers.</p> <p>ATTENTION !</p> <p>Les meubles contenant des panneaux à base de bois (panneaux de particules, panneaux de fibres, contreplaqué...) peuvent émettre des substances polluantes dans l'air intérieur. Il est ainsi recommandé, après l'installation du meuble dans son logement, d'aérer fréquemment la pièce concernée pendant au moins quatre semaines afin de réduire son exposition aux polluants émis par le meuble</p> <p>LED:</p> <p>Ce luminaire est un produit de décoration. Ce luminaire ne convient pas pour l'éclairage principal d'une pièce de la maison.</p>
UK	<p>Warning:</p> <p>If dowels and screws are included with the product, they are only intended for use on walls made of solid and uniform materials to prevent them from tipping over. Before drilling, make sure that there are no gas, water or electricity pipes at the drilling site. Special anchors must be used for fastening to other walls. Ask in the trade for the screws and or dowels suitable for the respective wall condition. The manufacturer accepts no liability for improper installation and any resulting damage. Please check and retighten all screws at regular intervals.</p>
IT	<p>Avvertenza:</p> <p>Se con il prodotto sono forniti tasselli e viti, questi sono destinati esclusivamente all'utilizzo su pareti realizzate con materiali solidi ed uniformi, per evitare il ribaltamento. Prima di eseguire i fori assicurarsi che non ci siano condutture di gas, acqua o elettriche vicino al punto di perforazione. Per il fissaggio ad altre pareti è necessario utilizzare tasselli speciali. Chiedere al proprio rivenditore le viti e/o tasselli adatti al tipo di parete in questione. Il produttore non si assume alcuna responsabilità in caso di montaggio improprio e dei danni che ne derivano. Controllare e serrare tutte le viti a distanza regolare.</p>
PL	<p>Ostrzeżenie:</p> <p>Jeżeli do towaru dołączone są kolki i śruby, są one przeznaczone wyłącznie do stosowania na ścianach wykonanych z solidnych i jednolitych materiałów, aby zapobiec przewróceniu. Przed rozpoczęciem wiercenia należy upewnić się, że w miejscu wiercenia nie są ułożone rury gazowe, wodociągowe lub przewody elektryczne. Do mocowania do innych ścian należy stosować kolki specjalne. O śruby lub kolki odpowiednie dla konstrukcji danej ściany należy pytać w sklepach specjalistycznych. Producent nie ponosi odpowiedzialności za nieprawidłowy montaż i wynikłe z tego tytułu szkody. Wszyskie śruby należy regularnie sprawdzać i dokręcać.</p>
ESP	<p>Advertencia:</p> <p>En el caso de incluirse tacos y tornillos con la mercancía, estos están previstos únicamente para su uso en paredes macizas y homogéneas a fin de evitar un posible vuelco. Antes de taladrar, asegúrese de que por el punto de perforación no pasan tuberías de gas o agua o cables eléctricos. Para la fijación en otro tipo de paredes deben utilizarse tacos especiales. Pregunte en la tienda por los tornillos o tacos adecuados para las características de la pared en cuestión. El fabricante no asume ninguna responsabilidad por un montaje incorrecto ni por los daños resultantes del mismo. Compruebe todos los tornillos en intervalos regulares y apríctelos.</p>
CZ	<p>Výstražné upozornění:</p> <p>Pokud jsou k výrobku přiloženy hmoždinky a šrouby, jsou určeny výhradně pro použití do sítň zhotovených z masivních a homogenních materiálů, a to za účelem zajištění proti převrácení. Před vrtáním se ujistěte, že se v místě vrtání nenachází vedení plynu, vody nebo elektriny. Pro připevnění k jiným stěnám je nutné použít speciální hmoždinky. Informujte se v obchodě o hmoždinkách a nebo šroubech vhodných pro příslušnou strukturu stěny. Výrobce nenes odpovědnost za nesprávnou montáž a za škody jí způsobené. Všechny šrouby pravidelně kontrolujte a dotahujte.</p>
SK	<p>Informácia o nebezpečenstve:</p> <p>Ak sú k tovaru priložené príchytky a skrutky, sú určené výlučne na použitie na stenách z masívnych a jednotných materiálov, aby sa zabránilo prevráteniu. Pred vrtaním sa uistite, že sa na vrtanom mieste nenachádzajú žiadne plynové, vodovodné alebo elektrické vedenia. Na upevnenie na iných stenách musia byť použité špeciálne príchytky. Spýtajte sa v predajni na skrutky a/alebo príchytky vhodné pre príslušný typ steny. Výrobca nepreberá rúenie za nesprávnou montáž a tým vzniknuté škody. Všetky skrutky v pravidelných intervaloch kontrolujte a dotiahnite.</p>
HU	<p>Figyelmeztetés:</p> <p>Amennyiben a termék csomagolásá tipliket és csavarokat is tartalmaz, azok kizárólag masszív, egységes anyagból készült falakon használhatóak, a felborulás megakadályozásának céljából. A fúrás előtt bizonyosodjon meg arról, hogy a fúrás helyén nem található gáz-, víz- vagy elektromos vezetékek. Egyes falakra történő rögzítéshez speciális tiplik szükségesek. Az egyes falpusokkal használható megfelelő csavarokkal és/vagy tiplikkel kapcsolatos információkért kérjük, forduljon forgalmazójához. A nem szakszertű szerelésért és az abból keletkező károokért a gyártót semmilyen felelősség nem terheli. Minden csavart ellenőrizzen és rögzítsen rendszeresen.</p>
BG	<p>Предупредително указание:</p> <p>Ако в комплектовката на доставката на стоката са включени дюбели и винтове, те са предназначени единствено за употреба върху стени от масивни и еднородни материали, да се предотврати преобръщане. Преди пробиване се уверете, че на мястото на пробиване няма тръби за газ, за вода или електрически проводници. За закрепване към други стени трябва да се използват специални дюбели. Информирайте се в търговската мрежа относно подходящите винтове или дюбели за съответната конструкция на стената. Производителят не поема отговорност за неправилна монтаж и възникнали в резултат на това щети. Моля, проверявайте и затягвайте всички винтове на редовни интервали.</p>
TR	<p>Uyarı:</p> <p>Ürün paketine dübel ve vida varsa, bunlar devrilmeyi önlemek amacıyla, sadece masif ve tekpare malzemelerden imal edilmiş duvarlardaki kullanim için öngörülmiştir. Matkapla delik açmadan önce delme noktasında gaz, su veya elektrik hatlarını olmaksızın emin olun. Ürünü başka duvarlara sabitlemek için özel dübeller kullanılmalıdır. Piyasadaki satıcılardan ilgili duvarın özelliğine uygun</p>

	<p>vidular ve díbelier hakkinda bilgi alın. Usulüne aykırı bir montaj ve bu nedenle oluşmuş hasarlar için üretici sorumluluk almamaktadır.</p> <p>Lütfen tüm vidaları dizenli aralıklarla kontrol edip tekrar sıkın.</p>
PT	<p>Advertência:</p> <p>Caso o produto venha com buchas e parafusos incluídos, os mesmos são exclusivamente destinados à fixação em paredes de materiais sólidos e uniformes, para evitar que o produto tombe. Antes de iniciar a perfuração, certifique-se de que não existem canalizações de gás, água ou fios elétricos a passar no local dos furos. Para a fixação noutro tipo de paredes, têm de ser utilizadas buchas especiais. Informe-se junto de um comerciante especializado sobre os parafusos e buchas a utilizar na parede específica. O fabricante não assume qualquer responsabilidade no caso de uma montagem inadequada e qualquer dano daí resultante. Verifique e volte a apertar todos os parafusos regularmente.</p>
SI	<p>Opozorilo:</p> <p>Če so blagu priloženi zidni vložki in vijaki, so ti namenjeni izključno za uporabo na stenah iz masivnih in enotnih materialov, da se prepreči prevrnitev. Pred vrtnanjem se prepričajte, da na mestu vrtnanja ni plinskih, vodnih ali električnih napeljav. Za pritrditev na druge stene je treba uporabljati posebne zidne vložke. Pozanimajte se v trgovini o vijakih in/ali zidnih vložkih, primernih za posamezno sestavo stene. Proizvajalec ne prevzema jamstva za nepravilno montažo in zaradi tega nastalo škodo. Vse vijake redno preverjajte in naknadno privijajte.</p>
NL	<p>Waarschuwing:</p> <p>Indien er bij het product pluggen en schroeven zijn meegeleverd, zijn deze uitsluitend bestemd om in muren van massieve en homogene materialen te gebruiken om te voorkomen dat het product kantelt. Controleer voordat u begint of er geen gas-, water- of elektriciteitsleidingen lopen waar u gaat boren. Voor de bevestiging aan andere soorten muren moeten speciale pluggen worden gebruikt. Informeer in de winkel welke schroeven en/of pluggen geschikt zijn voor de desbetreffende muur. De fabrikant is niet aansprakelijk voor een onjuiste montage en de daardoor ontstane schade. Controleer regelmatig of alle schroeven nog goed vastzitten en draai ze zo nodig vast.</p>
SRB	<p>Upozoravajuća napomena:</p> <p>Ako su uz robu priloženi tiplovi i zavrtnji, isti su namenjeni isključivo za primenu na zidovima od kompaktnih i homogenih materijala, kako bi se sprečilo prevrtanje. Pre bušenja se uverite da se na mestu bušenja ne nalaze vodovi za gas, vodu ili struju. Za fiksiranje na drugačijim zidovima moraju da se upotrebe specijalni tiplovi. Raspitajte se u trgovini o zavrtanjima i/ili tiplovima koji su adekvatni za dotičnu teksturu zida. Proizvođač ne preuzima nikakvu odgovornost za nestručnu montažu i štete koje su nastale na taj način. Sve zavrtnje kontrolišite i doteržite u redovnim intervalima.</p>
RO	<p>Indicație de avertizare:</p> <p>Dacă produsul este livrat împreună cu șuruburi și dibluri, acestea sunt destinate exclusiv utilizării pe pereți construiți din materiale masive și uniforme, pentru a preveni răsturnarea produsului. Înainte de a realiza găurile, asigurați-vă că nu există conducte de gaz, apă sau electricitate în locul pe care doriți să-l găuriți. Pentru prinderea pe alte tipuri de pereți, trebuie să utilizați dibluri speciale. Interesați-vă la magazinul specializat, pentru a găsi șuruburile și/sau diblurile potrivite pentru perețele dvs. Producătorul nu este responsabil, în cazul unui montaj necorespunzător pentru daunele rezultate. Vă rugăm să verificați toate șuruburile la intervale regulate și să le strângeți.</p>
HR	<p>Upozorenje:</p> <p>Ako su uz proizvod priložene tiplje i vijci, oni su namijenjeni isključivo za korištenje na zidovima od čvrstih i jednoličnih materijala kako bi se spriječilo prevrtanje. Prije bušenja provjerite da na mjestu bušenja nema električnih vodova, plinskih ili vodovodnih cijevi. Za pričvršćivanje na ostale zidove potrebno je koristiti posebne tiplje. Priklom kupnje raspitajte se kod svog prodavača o vijcima i tiplama koji su prikladni za odgovarajuću zidnu strukturu. Proizvođač ne odgovara za štete nastale uslijed nepravilne montaže. Sve vijke potrebno je redovito provjeravati i zategnuti.</p>
SE	<p>Varning:</p> <p>Om plugg och skruvar följer med produkten är de endast avsedda för väggar av massivt och enhetligt material för att förhindra att produkten vippas. Försäkra dig om att inga gas-, vatten- eller elledningar befinner sig på platsen som du ska borra innan du börjar. För fastsättning i väggens måste specialplugg användas. Informera dig i en butik om vilka skruvar och plugg som passar till vilken vägg. För en felaktig montering och skador som uppstår på grund av detta tar tillverkaren inget ansvar. Kontrollera och dra åt alla skruvar med jämna mellanrum.</p>
RUS	<p>Предупреждение:</p> <p>Если изделие поставляется вместе с дюбелями и шурупами, они предназначены исключительно для использования на стенах из монолитных и однородных материалов, чтобы предотвратить возможное обрушение. Перед началом сверления убедитесь, что на месте сверления нет газопровода, водопровода или электропроводки. Для крепления к другим стенам необходимо использовать специальные дюбели. Узнайте у продавца, какие шурупы или дюбели подходят для соответствующей структуры стены. Производитель не несет ответственности за неправильный монтаж и вызванный им ущерб. Регулярно проверяйте и подтягивайте все шурупы.</p>
UKR	<p>Попередження:</p> <p>Якщо до виробу додаються дюбелі та гвинти, вони призначені виключно для використання на стінах з однорідних матеріалів, щоб не допустити перекидання. Перед сверлінням переконайтеся, що на місці сверління немає ліній газу-, водопостачання чи електропроводки. Для кріплення до інших стін необхідно використовувати спеціальні дюбелі. Запитайте продавця, які гвинти та/або дюбелі підходять для стіни з відповідною структурою. Виробник не несе відповідальності за неправильний монтаж та збитки, що виникли внаслідок цього. Перевіряйте та підтягуйте всі гвинти через регулярні проміжки часу.</p>
LT	<p>Ispėjimas:</p> <p>Jei prie prekės pridėtos mūrvinės ir varžtai, jie skirti naudoti tik ant sienų, pagamintų iš tvirtų ir vienodų medžiagų, kad būtų galima išvengti apvirimo. Prieš gręždami įsitinkite, kad gręžiamoje vietoje nėra dujotiekio, vandentiekio ar elektros linijų. Tvirtinant prie kito tipo sienų reikia naudoti specialias mūrvines. Tiesraiškies pardavėjo atitinkamai sienos konstrukcijai tinkamų varžtų ir (arba) mūrvinių gamintojas neprisiima atsakomybės dėl netinkamo montavimo ir dėl jo atsiradusios žalos. Visus varžtus reguliariai tikrinkite ir priveržkite.</p>
LV	<p>Brīdinājums:</p> <p>Ja precei ir pievienoti dībeļi un skrūves, prece ir paredzēta izmantošanai tikai uz sienām, kas izgatavotas no cietiem un vienādīgiem materiāliem, lai novērstu apgāšanos. Pirms urbšanas pārbaucieties, ka urbumas vietā nav gāzes, ūdens vai elektropārvades līniju. Lai piesprīnātu pie citām sienām, jāizmanto speciāli dībeļi. Jauājiet savam izplatītājam par skrūvēt un/vai dībeļiem, kas ir piemēroti attiecīgajai sienas konstrukcijai. Ražotājs neuzņemas atbildību par nepareizu montāžu un no tās sēkojošajiem bojājumiem. Līdzu, regulāri pārbaudiet un pievelciet visas skrūves.</p>
EE	<p>Hoiatus!</p> <p>Kui tootele on kaasa pandud tüüblid ja kruvid, on need mõeldud kasutamiseks üksnes massiivset ja ühisest materjalist seintel, vältimaks ümberkukkumist. Veenudge enne puurimist, et puurimiskohas ei oleks gaasi- või veevõruid ega elektrijuhtmeid. Seentele kinnitamiseks tuleb kasutada spetsiaalseid tüüblid. Uurige kaubandusvõrgust, millised kruvid ja/või tüüblid konkreetse seina jaoks sobivad. Tootja ei võta endale mittenõuetekohasest paigaldamisest tingitud kahjude eest mingit vastutust. Kontrollige ja järelpingutage kõiki kruvisid regulaarselt.</p>